

THE ALKYLATION OF ALKANES

GUSTAV EGLOFF AND GEORGE HULLA

Universal Oil Products Company, Chicago, Illinois

Received June 1, 1945

CONTENTS

I. Introduction	323
II. Catalytic alkylation of alkanes	324
A. Aluminum chloride	324
1. Alkenes	324
2. Alkenyl halides	327
B. Aluminum chloride and alkali chloride	327
C. Aluminum bromide	331
D. Aluminum bromide and aluminum chloride	333
E. Zirconium chloride	333
F. Boron fluoride	333
G. Hydrogen fluoride	335
1. Alkenes	335
2. Alkyl fluorides	340
H. Sulfuric acid	340
III. Thermal alkylation	349
A. Alkenes	349
B. Methyl radicals	361
IV. Summary of the products of alkylation	367
V. Mechanism of alkylation	369
A. Catalytic alkylation	369
B. Thermal alkylation	396
VI. References	398

I. INTRODUCTION

The alkylation of alkanes was discovered in 1932 by Ipatieff and Pines in the research laboratories of the Universal Oil Products Company (24a). This fundamental reaction is the basis of three commercial processes for the production of *alkylate*, a primary component of 100-octane aviation gasoline. These processes use aluminum chloride, hydrogen fluoride, and sulfuric acid as catalysts for effecting a juncture of isobutane with propene, butenes, pentenes, or octenes. Ethene has been used as an alkylating agent in the presence of aluminum chloride. The three processes were producing alkylate at the rate of 5,500,000 gallons a day during the war period.

In 1936 the alkylation of isobutane by isobutene (2-methylpropene) to form 2,2,4-trimethylpentane was confirmed on thermodynamic grounds (43). Previously some chemists were dubious about the occurrence of a reaction requiring relatively low temperatures and involving alkanes believed to be chemically inert and to have low reaction velocities. Thermodynamics is not concerned with the catalyst or time required for the reaction.

The present review considers the available literature, exclusive of patents, on the alkylation of alkanes. Patents will be reported upon at a later date. Seven

alkylations with three normal alkanes (propane, butane, and hexane) and fifty alkylations with three branched-chain alkanes (isobutane, isopentane, and 2,2,4-trimethylpentane) are discussed in the following pages. Of these fifty-seven alkylations, seven use aluminum chloride; four use aluminum chloride plus alkali chloride; four use aluminum bromide; one uses aluminum bromide plus aluminum chloride; one uses zirconium chloride; six use boron fluoride; eight use hydrogen fluoride; twenty use sulfuric acid; and one uses phosphoric acid as catalyst. Five alkylations are thermal reactions. Isobutane has been alkylated by fifteen alkenes, one alkadiene, four alkyl halides, one dialkyl sulfate, and two alkenyl chlorides. Isobutane reacts with ethene to yield mainly 2,2-dimethylbutane (thermally) or 2,3-dimethylbutane (catalytically, except in the presence of sulfuric acid). Mechanisms of alkylation proposed by eight groups of investigators are presented.

II. CATALYTIC ALKYLATION OF ALKANES

The chief catalysts for the alkylation of alkanes have been found to be aluminum chloride or bromide and modifications thereof, zirconium chloride, boron fluoride, hydrogen fluoride, and sulfuric acid. These catalysts lead to the formation of typical alkylates whose production and composition will next be considered.

A. ALUMINUM CHLORIDE

1. Alkenes

Alkanes from butane to dodecane have been alkylated by alkenes in the presence of aluminum chloride (30). The alkylations occurred at 25–40°C. under 1–15 atmospheres pressure, producing colorless alkylated alkanes and a brown lower layer composed of aluminum chloride in combination with high-boiling unsaturated hydrocarbons. Experimental data were given for the alkylation of isobutane and *n*-hexane by ethene under mild pressure conditions (table 1).

The data of table 1 demonstrate that isobutane and *n*-hexane reacted with ethene to form a series of ethylated (or rearranged methylated) hydrocarbons. All of the alkylations were complicated by side reactions yielding alkanes with an odd number of carbon atoms. Three side reactions, namely, "autodestructive alkylation" of alkanes (27), conversion of ethene or other alkenes into alkanes (29), and formation of aluminum chloride–hydrocarbon complexes, were mentioned as occurring simultaneously, though to an extent varying with the experimental conditions. "Autodestructive alkylation" of alkanes consists in the splitting of an alkane into a lower alkane and an alkene that reacts with another molecule of the initial alkane to form a higher alkane; it causes the formation of alkanes with more and less carbon atoms than the primary alkylate. Conversion of ethene into by-product alkanes appears to involve a polymerization of ethene with subsequent hydrogenation of the alkene polymers. The requisite hydrogen atoms are derived from the unsaturated hydrocarbons that combine with aluminum chloride to form deep red-brown viscous lower layers. A certain amount of hydrogen chloride appears to be necessary for the occurrence

of an alkylation in the presence of aluminum chloride (24). This hydrogen chloride may be added as such or may be derived from alkyl chlorides or from sludge formation. We presume that one function of hydrogen chloride is to produce monomeric aluminum chloride, i.e., $(\text{AlCl}_3)_1$, both by dissociation of associated molecules of aluminum chloride and by decomposition of aluminum chloride-hydrocarbon complexes. Hydrogen chloride exhibits an ability to

TABLE 1
Alkylation of isobutane and n-hexane by ethene in the presence of aluminum chloride
 (Ipatieff, Grosse, Pines, and Komarewsky)

Reaction conditions:			
Isobutane, grams.....	62.3	0	0
n-Hexane, grams.....	0	147.7	150
Ethene, grams.....	95.6	61.3	100-110
AlCl_3 , grams.....	22.4	25.1	30
Anhydrous HCl.....		"A little"	
Temperature, °C.....	25	40	25
Time, hours.....	10	15	36
Pressure, atmospheres.....	15 (max.)	1	15 (max.)
Uncondensed gas, grams.....	4.9	0	0.4
Weight upper layer, grams.....	142.0	158.0	225
Weight lower layer, grams.....	31.8	60.5	50-55
Fractionation of upper layer:			
Amount fractionated, grams.....	135	158	220
Main fractions, grams:			
<i>B.p., °C.</i>	<i>Composition</i>		
20- 45	C_6H_{12}	9.9	
25- 50	C_6H_{12}	7.4	4.4
45- 85	C_6H_{14} - C_7H_{16}	49.2	
50- 70	C_6H_{14}	11.5	
50- 75	C_6H_{14}		75.1
70-100	C_7H_{16}	24.3	
75-100	C_7H_{16}		10.85
85-125	C_7H_{16} - C_8H_{18}	25.6	
100-125	C_8H_{18}	24.6	18.15
125-150	C_9H_{20} - $\text{C}_{10}\text{H}_{22}$		12.05
125-160	C_9H_{20} - $\text{C}_{10}\text{H}_{22}$	13.3	
125-170	C_9H_{20} - $\text{C}_{10}\text{H}_{22}$		25.6
Higher fractions, grams.....	51.6	40.6	94.05

react with or decompose organic complexes containing metal salts, such as aluminum chloride. Another function of hydrogen chloride may be to add to the alkenes present, yielding alkyl chlorides that serve as alkylating agents. Early speculations (16) as to whether the most active form of the catalyst is $(\text{AlCl}_3)_1$ or hydrogen aluminum chloride, i.e., HAlCl_4 , appear to have been resolved in favor of monomeric aluminum chloride. It is known that HAlCl_4 , if capable of existence, has a very high dissociation pressure at ordinary temperature (24). Consequently, its formation would serve to maintain an effective supply of monomeric aluminum chloride.

Partly published results of Pines, Grosse, and Ipatieff have revealed that hexanes can be made the major product in the aluminum chloride-catalyzed alkylation of isobutane by ethene under pressure at room temperature (26):

PRODUCT	YIELD
	<i>volume per cent</i>
Isopentane.....	16.0
Hexanes.....	41.0
Heptanes.....	9.4
Octanes.....	12.3
Nonanes.....	6.5
Higher alkanes.....	14.8

A subsequent study identified the products formed in the catalytic alkylation of isobutane by ethene at 25–35°C. under a maximum pressure of 10 atmospheres in the presence of aluminum chloride and hydrogen chloride (20). The hexane fraction constituted 45 per cent of the total liquid product and was found by parallel chemical and Raman spectroscopic examinations to contain 10–25 per cent of 2-methylpentane, less than 3 per cent of 2,2-dimethylbutane, and 70–90 per cent of 2,3-dimethylbutane.

Ipatieff (26) advanced the idea that alkylation of C₄ or higher alkanes by alkenes in the presence of aluminum chloride probably involves reaction of the alkane (preferably in branched form) with an aluminum chloride-alkene complex. In the alkylation of isobutane by ethene, taken as an example, the expected products were 2,2-dimethylbutane and a lesser amount of 2-methylpentane. Since the main product among the hexanes was 2,3-dimethylbutane, it was assumed to be an isomerization product of the primarily formed 2,2-dimethylbutane. Other products, such as isopentane and undecanes, were ascribed to the operation of autodestructive alkylation, e.g.,

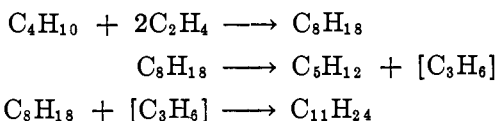

or

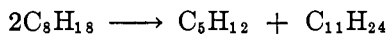

Non-reactivity of propane toward alkylation was ascribed to its lack of a tertiary carbon atom, as well as the impossibility of its isomerization into an isomer containing such an atom. Propane, however, reacts extensively with ethene or propene in thermal alkylation under pressure.

Alkylation of isobutane by propene and mixed *n*-butenes (33 per cent 1-butene and 67 per cent 2-butene) in the presence of aluminum chloride and anhydrous hydrogen chloride was studied at low temperatures, permitting operation in the liquid phase at atmospheric pressure (44). A continuous-operation glass apparatus was designed for regulation of the temperature, contact time, and feed rate. The reaction of isobutane with propene was carried out at –30°C. with a con-

tact time of approximately 4 min. A total of 3230 cc. of liquefied hydrocarbons (23 mole per cent of propene) was brought into contact with 15 g. of aluminum chloride, and hydrogen chloride was introduced simultaneously. The liquid product, which amounted to 650 cc., contained 42 per cent of heptanes (mainly 2,3-dimethylpentane with some 2,4-dimethylpentane, according to Raman spectroscopic analysis (46)) and 20 per cent of decanes. Ninety per cent of the liquid distilled below 220°C. Isobutane and *n*-butenes under similar conditions (-35°C., aluminum chloride and hydrogen chloride as catalyst) gave a liquid product containing alkanes only, including over 60 per cent of octanes and 12 per cent of dodecanes. By means of Raman spectra, these octanes were found to be 2,5-dimethylhexane and 2,2,3-, 2,2,4-, and 2,3,4-trimethylpentanes.

The reaction of isobutane with isopropyl chloride in the presence of aluminum chloride at 40-70°C. does not yield heptanes as the major product. Instead, reduction of the alkyl chloride to propane occurs to the extent of 60-90 per cent; the isobutane furnishes the hydrogen and is converted chiefly into octanes and catalyst complex (53).

2. Alkenyl halides

A study of the condensation of alkanes with alkenyl halides in the presence of aluminum chloride has led to a new method of preparation of haloalkanes as well as the corresponding alkanes (48). By proper choice of reaction conditions, e.g., at temperatures above 0°C., an interaction of 1.5 moles of isobutane with 1 mole of allyl chloride could be obtained, yielding liquid alkanes to the extent of 310 per cent by weight of the propene available from the allyl chloride. At lower temperatures the conversion ends with the formation of 1-chloro-3,4-dimethylpentane and 1,2-dichloro-4,4-dimethylpentane; it was stated that these react with more isobutane at the higher temperatures to form alkanes and hydrogen chloride. Liquid isoalkanes were also formed in the condensation of isobutane with vinyl chloride; about 10 per cent of *tert*-butyl chloride and up to 40 per cent of 1,1-dichloro-3,3-dimethylbutane were by-products of the reaction.

B. ALUMINUM CHLORIDE AND ALKALI CHLORIDE

Isobutane has been alkylated by gaseous alkenes in the presence of pumice coated with double compounds of aluminum chloride and alkali chlorides (10). These alkylations were complicated by a competing polymerization of alkenes and by side reactions forming gasoline-range hydrocarbons with intermediary numbers of carbon atoms. Mixtures of the alkenes with isobutane in excess were passed over the catalysts under pressures of about 1000 psi¹ and temperatures of 154-291°C. Ammonium aluminum chloride (NH₄AlCl₄) was found to be somewhat less active than lithium aluminum chloride (LiAlCl₄) or sodium aluminum chloride (NaAlCl₄); it required a temperature of about 232°C. for any substantial activity. Potassium aluminum chloride (KAlCl₄) was nearly inactive, showing some polymerization of alkene at 316°C.

¹ psi = gage pressure in pounds per square inch.

Table 2 gives the results of two tests in which isobutane and propene were reacted over lithium aluminum chloride on pumice. In each case the products were collected in two parts. Their analyses indicate that the alkylating ability of the catalyst declined rapidly (*cf.* liquid volume percentage of C₇ hydrocarbons and of alkenes therein; see also figure 1). The catalyst after use was found covered with a heavy carbon deposit that penetrated into the interior of the catalyst particles. An optimum temperature around 227°C. was found for the

TABLE 2
Alkylation of isobutane with propene over lithium aluminum chloride on pumice
(Blunck and Carmody)

Run No.....	42-A	42-B	43-A	43-B
Temperature, °C.....	285	287	288	291
Pressure, psi.....	1000	1200	1200	1200
Flow rate (liquid feed volume per volume of catalyst per hour).....	1.59	1.59	1.76	1.57
Duration, hours.....	5.0	4.5	6	8
Feed composition, mole per cent:				
Isobutane.....	67	65	65	65
Propene.....	33	35	35	35
Catalyst, cc.....	100	100	100	100
Yield, per cent*.....	17.0	9.8	17.8	11.0
Products, liquid volume per cent on C ₅₊ :				
C ₅	6.6	0.6	2.5	1.3
Unsaturated in C ₅	1.5			
C ₆	11.6	6.5	10.3	6.0
Unsaturated in C ₆	1.5	28.2	9.5	48.0
C ₇	35.6	16.7	25.8	11.2
Unsaturated in C ₇	2.5	40.3	14.0	65.7
C ₈	11.1	15.8	12.9	13.3
Unsaturated in C ₈	6.5	52.0	18.5	67.2
C ₉	12.8	21.0	14.3	24.3
Unsaturated in C ₉	35.7	9.0	58.7	25.0
C ₁₀₊	22.3	39.4	33.2	43.9

* Weight per cent yield, based on the weight of heptane that would have been produced by the union of all the alkene in the feed, mole for mole, with isobutane.

production of liquid hydrocarbons from a feed containing 35–40 mole per cent of propene in isobutane over lithium aluminum chloride on pumice and 1000–1200 psi (figure 2, top curve). The lower portion of figure 2 gives the volume percentage of individual hydrocarbon cuts of the product, measured by the distance between solid curves, and the volume percentage of alkenes in these cuts as the distance between a broken line and the solid line immediately below it. A rise in temperature increased the catalyst's selectivity towards alkylation into heptanes at the expense of the polymer products, total yield of liquid products, and life of the catalyst.

Table 3 gives the results for the alkylation of isobutane by ethene, propene,

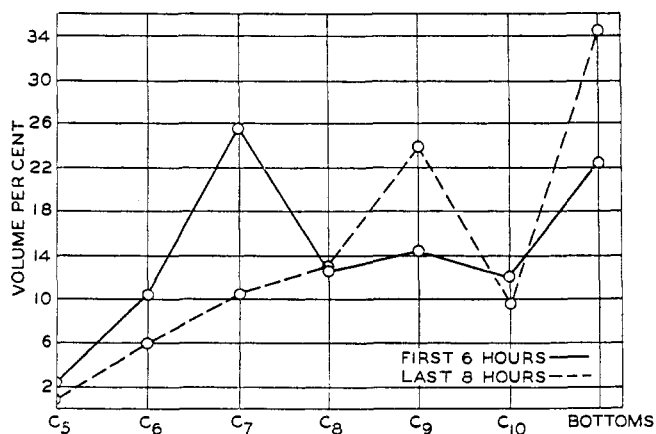

Fig. 1. Effect of age of catalyst on distribution of products (Blunck and Carmody)

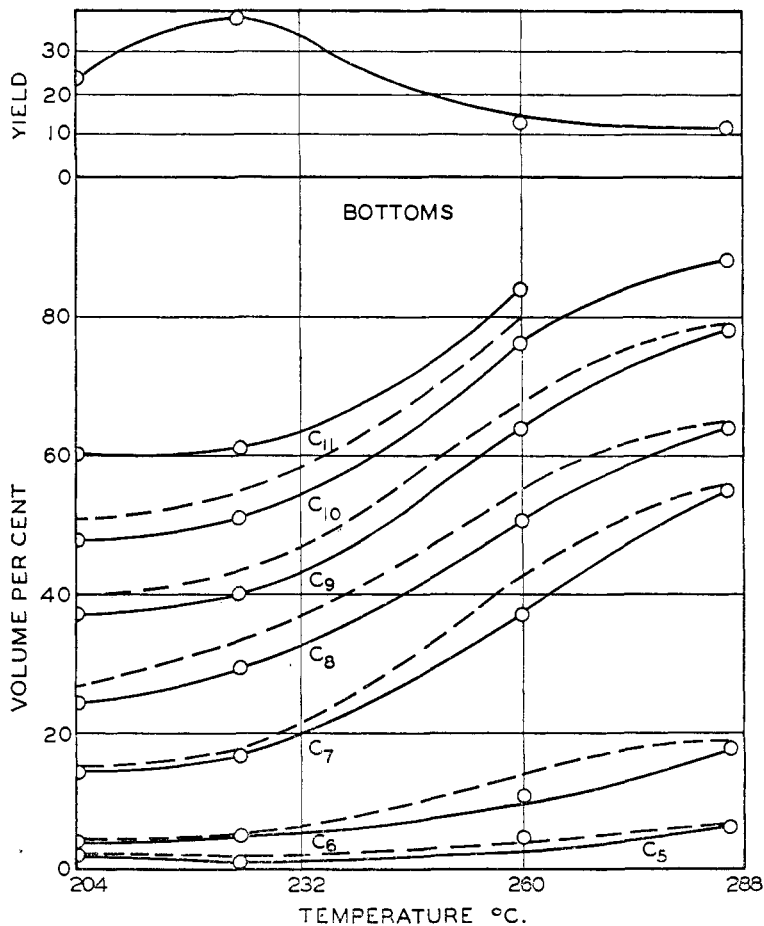

Fig. 2. Effect of temperature on yield and on product distribution (Blunck and Carmody)

TABLE 3
Alkylation of isobutane with alkenes over sodium aluminum chloride on pumice
(Blunck and Carmody)

	ISOBUTENE						PROPENE			ETHENE		
	1	2	3	4	5	6	7	8	9	10	11	12
Run No.....												
Feed, mole per cent:												
Isobutane.....	95	90	90	85	77	90	80	80	50	95	94	85
Alkene.....	5	10	10	15	23	10	20	20	50	5	6	15
Temperature, °C.....	204	204	157	204	171	196	104	218	218	154	171	171
Pressure, psi.....	1000	1000	1000	1000	1000	0	1000	1000	1000	1000	1000	1000
Flow rate, vol./vol./hr.....	1.5	2.1	4.8	1.6	5.0	1.5	3.7	3.6	3.8	4.0	3.2	1.8
Duration of run, hours.....	2.5	3.25	2.5	4.5	2.0	3.0	2.2	2.0	2.4	2.0	2.0	3.0
Yield, per cent*.....	93	83	27		60	32.5	46	56	25	30	25	
Products, liquid volume per cent on C ₆₊ :												
C ₅ , per cent.....	14.8	16.8	8.8	17.6	3.0	11.8	13.0	11.8	12.0	6.2	13.0	12.5
Unsaturated, per cent....	4.0	4.0	8.0	10.0	30.0	35.0	Slight†	Slight	5	Complete saturation		
n _D ²⁰	1.3695	1.3560	1.3562	1.3560	1.3583	1.3745	1.3560	1.3615	1.3615	1.3620	1.3615	1.3620
C ₆ , per cent.....	9.6	9.6	7.2	7.7	5.5	8.8	9.3	8.5	10.0	12.4	29.0	25.0
Unsaturated, per cent....	10	10	10	16	35	40	0	Slight	7	Complete saturation		
n _D ²⁰	1.3810	1.3765	1.3769	1.3782	1.3710	1.3845	1.3746	1.3740	1.3754	1.3680	1.3695	1.3693
C ₇ , per cent.....	6.8	9.3	5.6	7.7	5.1	5.9	17.1	15.8	12.0	12.4	13.0	12.5
Unsaturated, per cent....	6.0	14.0	9.0	16.0	25	35	0	Slight	8	Complete saturation		
n _D ²⁰	1.3960	1.3920	1.3860	1.3920	1.3920	1.4055	1.3850	1.3879	1.3865	1.3810	1.3850	1.3840
C ₈ , per cent.....	29.5	30.0	40.8	29.5	38.0	44.1	14.5	11.0	11.0	37.2	32.0	25
Unsaturated, per cent....	14.1	13.0	10.0	13.4	20.0	30.4	0	Slight	8	Complete saturation		
n _D ²⁰	1.4090	1.4060	1.3900	1.4075	1.4110	1.4170	1.3890	1.3879	1.3990	1.3915	1.3916	1.3917
C ₉₊ (bottoms).....	49.3	44.0	37.0	37.0	48.4	29	46.1	52.9	55.0	31.8	13.0	25.0

* For definition, see table 2.

† Within the experimental error of 2 per cent.

or isobutene over sodium aluminum chloride on pumice. The optimum temperature for this catalyst was stated to be in the neighborhood of 218°C. In the case of ethene, the C₅, C₆, C₇, and C₈ fractions of the product were completely saturated. This indicates a tendency to alkylate instead of polymerize. Isobutene, however, led to corresponding fractions with 4–40 per cent of alkenes. Propene gave fractions with intermediary percentages of unsaturates. Alkylation was progressively easier in the order ethene, propene, isobutene, but the specificity of the reaction decreased; this indicates that the polymerization tendency increased more rapidly than the alkylation tendency. Figure 3 gives the effect of increased space velocity of feed containing 50 mole per cent each of iso-

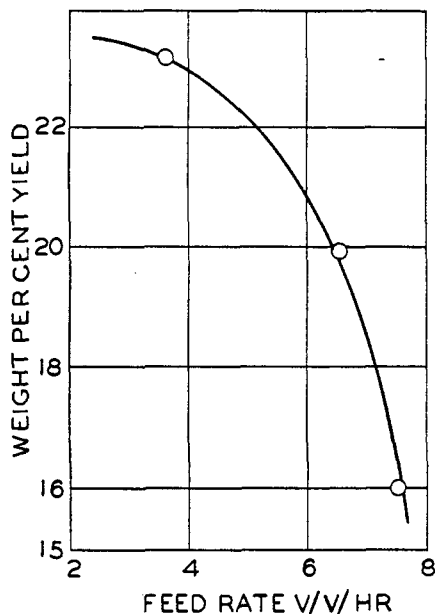

FIG. 3. The effect of increased space velocity of feed containing 50 mole per cent each of isobutane and propene upon the weight per cent yield of liquid products at 218°C. and 1000 psi over sodium aluminum chloride on pumice (Blunck and Carmody).

butane and propene upon the weight per cent yield of liquid products at 218°C. and 1000 psi over sodium aluminum chloride on pumice. A feed rate greater than 4.0 volumes of feed per volume of catalyst per hour caused the yield to fall off rapidly. The corresponding products were more unsaturated, in agreement with a considerably slower rate for alkylation than for polymerization.

C. ALUMINUM BROMIDE

Alkylations of *n*-butane and isobutane by methyl or ethyl bromide have been reported (23). The treatment of *n*-butane with methyl bromide and aluminum bromide at 25–78°C. gave isobutane and isopentane to the extent of 20.6 and 1.5–17.3 mole per cent on *n*-butane introduced, respectively. No alkylation or

isomerization of *n*-butane occurred in the presence of methyl chloride and aluminum chloride at 25°C. This inactivity was probably due to complete removal of aluminum chloride as a soluble complex (isolated) containing methyl chloride. *n*-Butane, ethyl bromide, and aluminum bromide at 25°C. yielded isobutane and an alkylate containing hexanes, corresponding to 47.7 and 20.8–30 mole per cent

TABLE 4
Alkylation of alkanes by alkyl halides
(Heldman*)

REACTANTS						CONDITIONS		PRODUCTS†	
Alkane		Alkyl halide		Catalyst		Time hours	Temperature °C.	Formula	Moles
Formula	Moles	Formula	Moles	Formula	Moles				
C ₃ H ₈	0.0230	CH ₃ Br	0.0392	Al ₂ Br ₆	0.00167	120 =	25 ± 3		0
<i>n</i> -C ₄ H ₁₀	0.0500	CH ₃ Br	0.0392	Al ₂ Br ₆	0.00143	95.8	25.0	Iso-C ₄ H ₁₀	0.0103
								Alkylate	<0.00075
<i>n</i> -C ₄ H ₁₀	0.0750	CH ₃ Br	0.0392	Al ₂ Br ₆	0.00158	120	25 ± 3	Iso-C ₄ H ₁₂	0.0052
<i>n</i> -C ₄ H ₁₀	0.0250	CH ₃ Br	0.0392	Al ₂ Br ₆	0.00181	96	25.0	Alkylate	0.0033
<i>n</i> -C ₄ H ₁₀	0.0500	CH ₃ Br	0.0392	Al ₂ Br ₆	0.00342	68.8	25 ± 3	Alkylate	0.0083
<i>n</i> -C ₄ H ₁₀	0.0753	CH ₃ Br	0.0390	Al ₂ Br ₆	0.00183	64.8	78 ± 2	Iso-C ₅ H ₁₂	0.0130
<i>n</i> -C ₄ H ₁₀	0.0500	CH ₃ Cl	0.0860	Al ₂ Cl ₆	0.00292	90	25 ± 3		0
<i>n</i> -C ₄ H ₁₀	0.0250	C ₂ H ₅ Br	0.0183	Al ₂ Br ₆	0.000638	72	25.0	Iso-C ₄ H ₁₀	0.0119
								Alkylate	0.0052
<i>n</i> -C ₄ H ₁₀	0.0500	C ₂ H ₅ Br	0.0262	Al ₂ Br ₆	0.00252	42	25 ± 3	Alkylate	0.0150
Iso-C ₄ H ₁₀	0.0520	CH ₃ Br	0.0392	Al ₂ Br ₆	0.00142	283	25 ± 3	<i>n</i> -C ₄ H ₁₀	0.0062
								Iso-C ₄ H ₁₀	0.0410
								Iso-C ₅ H ₁₂	0.0034
								Higher alkylate	0.0024
Iso-C ₄ H ₁₀	0.0494	CH ₃ Br	0.0580	Al ₂ Br ₆	0.00169	47.8	50 ± 1	Alkylate	0.0062
Iso-C ₄ H ₁₀	0.0741	C ₂ H ₅ Br	0.0642	Al ₂ Br ₆	0.00310	47.8	50 ± 1	CH ₄	trace
								C ₂ H ₆	0.0140
								C ₃ H ₈	0.0080
								<i>n</i> -C ₄ H ₁₀	0.0082
								Iso-C ₄ H ₁₀	0.0185
								Iso-C ₅ H ₁₂	0.0130
								Higher alkylate	0.0095

* Heldman's original data retabulated by the present authors.

† Including unconverted or isomerized starting alkane and lower alkanes when reported.

on *n*-butane introduced, respectively. Isobutane, methyl bromide, and aluminum bromide at 25°C. formed *n*-butane, isopentane, and higher alkanes, amounting respectively to 12, 6.5, and 4.6 mole per cent on isobutane introduced. With isobutane, ethyl bromide, and aluminum bromide at 50°C., the products were ethane, propane, *n*-butane, isopentane, and higher alkanes including hexane, corresponding respectively to 18.9, 10.8, 11.1, 17.5, and 12.8 mole per cent on isobutane introduced. No alkylation of propane by methyl bromide and

aluminum bromide at 25°C. occurred even with a contact time of 120 hr. These alkylation experiments are summarized in table 4. Large quantities of lower alkanes are indicated as by-products of the reaction of isobutane with ethyl bromide at 50°C. The possibility of an autodestructive alkylation of butanes



should not be forgotten in an evaluation of the foregoing experiments.

D. ALUMINUM BROMIDE AND ALUMINUM CHLORIDE

n-Butane has been alkylated by ethene under 15 atmospheres pressure in the presence of a mixture of aluminum bromide and aluminum chloride without any hydrogen halide as a promoter (24b). About 44.5 per cent of the *n*-butane enters into the reaction. A typical product is obtained, the upper layer of which contains alkanes distilling from 45°C. to above 150°C. The lower layer yields a small amount of unsaturated hydrocarbons when treated with ice water. We presume that aluminum bromide is the more active (less associated) component of the mixed catalyst.

E. ZIRCONIUM CHLORIDE

Ipatieff and his coworkers have disclosed that zirconium chloride is a considerably less active catalyst than aluminum chloride in the alkylation of isobutane by ethene; a temperature of 100°C. or over is required (25). About 50 per cent of isobutane was alkylated by ethene under 15 atmospheres pressure at 100°C. in the presence of zirconium chloride. The product consisted of a colorless mobile liquid and a dark pasty mass exhibiting catalytic activity. In the colorless liquid were alkanes distilling up to 200°C. and representing 70 per cent of all hydrocarbon produced. These alkanes were formed by the addition of one to three molecules of ethene to a molecule of isobutane. Practically all of the zirconium chloride was contained in the dark pasty mass. This was used as catalyst for a 34-hr. run in which isobutane was alkylated by ethene at 100°C. and 35–45 atmospheres pressure.

F. BORON FLUORIDE

Alkylation of isoalkanes with alkenes has been carried out in the presence of boron trifluoride, finely divided nickel, and small quantities of water or hydrogen fluoride (28). The reaction took place at room temperature, although temperatures as high as 200°C. were used occasionally, and a pressure of 5–20 atmospheres was found desirable. Alkylations of (1) isobutane with ethene, (2) isopentane with ethene, (3) 2,2,4-trimethylpentane with ethene, and (4) isobutane with isobutene were reported (table 5).

The data indicate that the alkylations were complicated by side reactions producing alkanes with an intermediary number of carbon atoms. From the wide range of products formed, it is obvious that the ethylation or butylation of lower isoalkanes was not highly selective, although alkylation without cracking was about 75 per cent. The general reaction was considered to be a direct addi-

tion of an alkene to the tertiary carbon atom of an isoalkane, according to the equation:

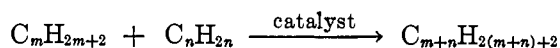

A further alkylation gives alkanes with the formula $C_{m+2n}H_{2(m+2n)+2}$. An abnormal behavior of 2,2,4-trimethylpentane under ethylation was observed; the isoalkane reacted slowly, and the ethene polymerized in part to high-boiling unsaturated hydrocarbons.

A later paper (20) describes the products from the alkylation of isobutane by ethene at 0–5°C. or –30° to –40°C. in the presence of boron fluoride, hydrogen fluoride, and nickel. In the experiment at 0–5°C., hexanes made up 45 per cent

TABLE 5

Alkylation of isoalkanes by alkenes in the presence of boron fluoride, hydrogen fluoride, and nickel

(Compiled from data of Ipatieff and Grosse)

Isoalkane used.....	Isobutane	Isopentane	2,2,4-Trimethyl- pentane	Isobutane
Alkene used.....	Ethene	Ethene	Ethene	Isobutene
Temperature, °C.....	20–30	150	25	25
Composition of the reaction product (volume per cent):				
Isobutane.....	7	0		11
Isopentane.....	2	60		} 5.2
Isohexanes.....	19	6.6		
Isoheptanes.....	6	5.8		2.7
Isooctanes.....	22	5.9	+	32
Isononanes.....	} 44	3.8		} 12.6
Isodecanes.....		3.3	5–10	
Isoundecanes.....				
Isododecanes.....		14.6	+	15
Higher alkanes.....				21.5

of the total liquid product. The hexane fraction in all cases contained 10–25 per cent of 2-methylpentane, less than 3 per cent of 2,2-dimethylbutane, and 70–90 per cent of 2,3-dimethylbutane. Other hexanes were probably absent; the products were investigated both chemically and Raman spectroscopically (21). The possibilities of side reaction were also considered (20):

“It should be stressed that in catalytic reactions the lowering of the energy barrier of the desired reaction brought about by the particular catalytic mechanism, markedly increases also the probability of undesired reactions. This is particularly true for reactions among hydrocarbons. Furthermore, the energy given off by the desired reaction stimulates the undesired reactions by providing the necessary activation energy. The cumulative effect is such that it is highly optimistic to expect the simple reaction mixture encountered in most inorganic or organic reactions. In the field of catalytic hydrocarbon reactions one can hope to surmount these difficulties only by picking the simplest hydrocarbons or de-

veloping highly selective catalysts and allowing them to work under carefully selected conditions."

Such catalysts and conditions have since been found.

G. HYDROGEN FLUORIDE

1. Alkenes

Alkylations of isobutane and isopentane have been effected by propene or butenes in the presence of liquid hydrogen fluoride (35). Owing to wartime

TABLE 6
Alkylation of isobutane and isopentane
(Linn and Grosse)

Temperature, °C.....	10	10	10	10	10	10	10	38
Reaction time, hours.....	5.0	5.0	5.0	5.0	5.0	5.0	5.0	
Catalyst:hydrocarbon ratio.....	0.13	0.16	0.16	0.16	0.16	0.15	0.15	1.1
Isoalkane:alkene mole ratio.....	3.5	3.0	3.3	3.2	3.5	3.3	1.5	6
Charging stock, mole per cent:								
Propene.....	22	25	0	0	0	0	0	4‡
Isobutene.....	0	0	0	0	22	19	20	
1-Butene.....	0	0	21	4	0	0	0	2
2-Butene.....	0	0	2	20	0	0	0	9.5
Isobutane.....	0	75	77	76	78	62	30	72
n-Butane.....	0	0	0	0	0	19	50	11.5
Isopentane.....	78	0	0	0	0	0	0	0.5
Liquid alkylate yield:								
Weight per cent alkene reacted..	272*	230	194	203	197	210	168	227
Fluorine in alkylate, per cent†..	0.08	0.01	0.01	0.01	0.01	0.01	0.01	0.026
150°E.P. gasoline, weight per cent of product.....	73	81	85	91	91	89	69	95
Octane No., 150°E.P. gasoline...		90.5	92.7	95.3	96.7	95.6	92	94.9

* Exclusive of pentanes; counting isobutane formed as product, the yield was 291 per cent.

† Not treated to remove fluorine. In commercial operations this is always done. After treatment the fluorine content was 0.0056 per cent.

‡ Propene + propane.

restrictions considerable data remain unpublished, though several patents have been granted. Some of the accessible data are summarized in tables 6-8.

Table 6 contains data for seven batch runs carried out with pure reactants at 10°C. and one continuous run using a commercial butane-butene cut (BB fraction) at 38°C. The interaction of isobutane and propene gave a desirable product containing 50 per cent of heptanes, including 2,3-dimethylpentane, besides 2,2,4-trimethylpentane. 2-Butene showed a definite advantage over 1-butene in the alkylation of isobutane to form a motor fuel. 2-Pentene likewise showed similar advantages over 1-pentene in the alkylation of isobutane. The products

from these 2-alkene examples were superior in octane number and aviation gasoline content. Isobutane and isobutene formed much 2,2,4-trimethylpentane, which was reflected in the 96.7 octane number of the 150°C. end point gasoline produced. A marked reduction in the yield and quality of the alkylate occurred when the charge contained 50 per cent of *n*-butane. Isopentane and propene reacted non-selectively, producing 291 weight per cent of alkylate based on propene reacted. Isobutane and only 26 per cent of octanes were present in the product, indicating that an autodestructive alkylation had occurred. In all cases the fluorine content of the alkylate was low and easily removed by activated charcoal, calcium fluoride, or aluminum fluoride at elevated temperatures.

Table 7 identifies some of the alkanes formed in the alkylation of isobutane and isopentane. Isobutane and propene produced 2,3- and 2,4-dimethylpentanes, which products were formed along with 2,3- and 2,5-dimethylhexanes from isopentane and propene. Both *n*-butenes and isobutene reacted with isobutane to form 2,2,4-trimethylpentane.

TABLE 7
Alkanes identified in reaction products
(Linn and Grosse)

ALKANES USED	ALKENES USED	BOILING RANGE OF SAMPLE AT 750 MM.	ALKANES IDENTIFIED
		°C.	
Iso-C ₄ H ₁₀	C ₃ H ₆	75.7- 79.0	2,4-Dimethylpentane
Iso-C ₄ H ₁₀	C ₃ H ₆	83.5- 85.5	2,4-Dimethylpentane 2,3-Dimethylpentane
Iso-C ₄ H ₁₀	<i>n</i> -C ₄ H ₈	98.0- 99.0	2,2,4-Trimethylpentane
Iso-C ₄ H ₁₀	Iso-C ₄ H ₈	98.0- 99.0	2,2,4-Trimethylpentane
Iso-C ₅ H ₁₂	C ₃ H ₆	79.5- 81.0	2,4-Dimethylpentane
Iso-C ₅ H ₁₂	C ₃ H ₆	89.0- 90.0	2,3-Dimethylpentane
Iso-C ₅ H ₁₂	C ₃ H ₆	108.0-110	2,5-Dimethylhexane
Iso-C ₅ H ₁₂	C ₃ H ₆	115.0-116.0	2,3-Dimethylhexane

Table 8 gives data on the alkylation of isobutane by isobutene over an 85°C. temperature range. It indicates that the temperature can be varied considerably without adverse effect upon the properties of the alkylate.

The principal reactions, other than physical dissolution of hydrocarbons, occurring in the reaction zone under optimum conditions are apparently as follows:

- (1) Direct interaction of an isoalkane and alkene, either of which may be charged as such or may be the result of previous reactions.
- (2) Dealkylation of alkanes of high molecular weight.
- (3) Polymerization of alkenes to form alkenes of higher molecular weight.
- (4) Depolymerization.
- (5) Hydrogen-transfer reactions between alkenes to form saturated hydrocarbons and tars of low hydrogen content.
- (6) Hydrogen-transfer reactions between alkanes and alkenes to form an alkane corresponding to the alkene and an alkene corresponding to the alkane.

(7) Chain isomerization, particularly of the alkylate product.

A number of reactions take place, and a variety of products may be made by changing the balance of these reactions. The most desirable products are those of the direct combination of the isoalkane and alkene feeds. Conditions should be so chosen as to favor such a reaction within the limits of commercial practicability. The means of adjusting the balance between reactions lies in the control of the concentrations of the various reactants and reaction products. Isobutane alkylations are adversely affected by the presence of water in hydrogen fluoride; an excess of water leads to formation of alkyl fluorides.

Typical Raman spectrum analyses (21) of various narrow-boiling fractions obtained in the alkylation of isobutane and isopentane by alkenes in the presence of hydrogen fluoride or of other catalysts yielding similar alkylate fractions are given in table 9.

TABLE 8
Isobutane-isobutene alkylation
(Linn and Grosse)

Temperature, °C.....	-24	32	60
Hydrocarbon:HF ratio, by volume.....	0.8	0.2	0.8
Charge, grams:			
Iso-C ₄ H ₈	177	344	168
Iso-C ₄ H ₁₀	420	561	397
Butane-free product, grams.....	351	670	298
Properties of product:			
Bromine number.....	0	0	0
Per cent fluorine.....	0.4	0.1	0.6
Engler 50% Point, °C.....	127	115	130
Engler 205°C., E.P., per cent.....	85	94	83
Octane number, A.S.T.M. motor method.....	91.5	92.0	89.0

Alkylation of isobutane by propene, butenes, or pentenes in the presence of anhydrous liquid hydrogen fluoride has been developed to successful commercialization (19). Figure 4 is a schematic drawing of a typical alkylation unit. Single units containing as much as 20,000 gallons of hydrogen fluoride are in operation for the production of aviation gasoline with about 93 A.S.T.M. octane number. Charging stock to the units passes through charge pretreaters that remove organic impurities and water. Recycle isobutane is fed directly and in abundance to the reaction system, ensuring satisfactory alkylation. The reaction is exothermic and is carried out advantageously at higher process temperatures than those used in alkylation with sulfuric acid. Defluorinating agents such as bauxite are used to remove from the final product small amounts of alkyl fluorides, which are converted into alkenes and hydrogen fluoride.

Operating features of the first commercial hydrogen fluoride alkylation plant were revealed after a year of operation by the Phillips Petroleum Company

(17). Bauxite driers have been used to remove small amounts of water dissolved in isobutane and the alkene-containing feed (usually butenes but can be propene, pentenes, or higher alkenes). Hydrocarbon streams have been proportioned to give a desired several-fold excess of isobutane over alkene and then

TABLE 9
Data on alkylation
(Grosse, Rosenbaum, and Jacobson)

BOILING RANGE OF SAMPLE AT 750 MM.	ISOALKANE	ALKENE	CATALYST	TEM- PERA- TURE OF REACTION	ISOALKANES IDENTIFIED
°C.				°C.	
56.0- 57.0	Iso-C ₄ H ₁₀	C ₂ H ₄	AlCl ₃ , HCl	+30	100% 2,3-dimethylbutane
59 - 60	Iso-C ₄ H ₁₀	C ₂ H ₄	BF ₃ , H ₂ O	+30	90% 2,3-dimethylbutane; 10% 2-methylpentane
59 - 60.5	Iso-C ₄ H ₁₀	C ₂ H ₄	Solid H ₃ PO ₄	400	2-Methylpentane
79.0- 81.0	Iso-C ₄ H ₁₀	C ₃ H ₆	BF ₃ , HF	0	100% 2,4-dimethylpentane
85.0- 86.3	Iso-C ₄ H ₁₀	C ₃ H ₆	BF ₃ , HF	0	100% 2,3-dimethylpentane
95.0- 97.0	Iso-C ₄ H ₁₀	C ₃ H ₆	BF ₃ , HF	0	100% 2,2,4-trimethylpen- tane
75.7- 79.0	Iso-C ₄ H ₁₀	C ₃ H ₆	HF, 100%	+30	100% 2,4-dimethylpentane
83.5- 85.5	Iso-C ₄ H ₁₀	C ₃ H ₆	HF, 100%	+30	45% 2,4-dimethylpentane; 55% 2,3-dimethylpentane
83.5- 85.5	Iso-C ₄ H ₁₀	C ₃ H ₆	AlCl ₃ , HCl	-30	50% 2,4-dimethylpentane; 50% 2,3-dimethylpentane 65% 2,5-dimethylhexane;
108.5-110.0	Iso-C ₄ H ₁₀	<i>n</i> -C ₄ H ₈	AlCl ₃ , HCl	-30	15% 2,2,3-trimethylpen- tane; 5% 2,2,4-trimethyl- pentane
113.0-114.0	Iso-C ₄ H ₁₀	<i>n</i> -C ₄ H ₈	AlCl ₃ , HCl	-30	Mainly 2,3,4-trimethylpen- tane
98.0- 99.0	Iso-C ₄ H ₁₀	<i>n</i> -C ₄ H ₈	HF, 100%	+30	100% 2,2,4-trimethylpen- tane
98.0- 99.0	Iso-C ₄ H ₁₀	Iso-C ₄ H ₈	HF, 100%	+30	100% 2,2,4-trimethylpen- tane
79.5- 81.0	Iso-C ₅ H ₁₂	C ₃ H ₆	HF, 100%	+30	95% 2,4-dimethylpentane; 5% 2,2,3-trimethylbutane
89.0- 90.0	Iso-C ₅ H ₁₂	C ₃ H ₆	HF, 100%	+30	100% 2,3-dimethylpentane
108.0-110	Iso-C ₅ H ₁₂	C ₃ H ₆	HF, 100%	+30	Nearly pure 2,5-dimethyl- hexane
115.0-116.0	Iso-C ₅ H ₁₂	C ₃ H ₆	HF, 100%	+30	100% 2,3-dimethylhexane
89.0- 90.0	Iso-C ₅ H ₁₂	<i>n</i> -C ₄ H ₈	H ₂ SO ₄ , 98%	+30	60% 2,3-dimethylpentane; 40% 2-methylhexane
58.0- 60.0	Iso-C ₅ H ₁₂	<i>n</i> -C ₄ H ₈	H ₂ SO ₄ , 98%	+30	50% 2,3-dimethylbutane; 50% 2-methylpentane

introduced into reactors where the mixed hydrocarbons have come in contact with about an equal volume of recycle acid for periods of less than an hour at temperatures between 24° and 46°C. The exothermic heat of alkylation has been removed by cooling coils in the reactors. Recycle acid has been partially

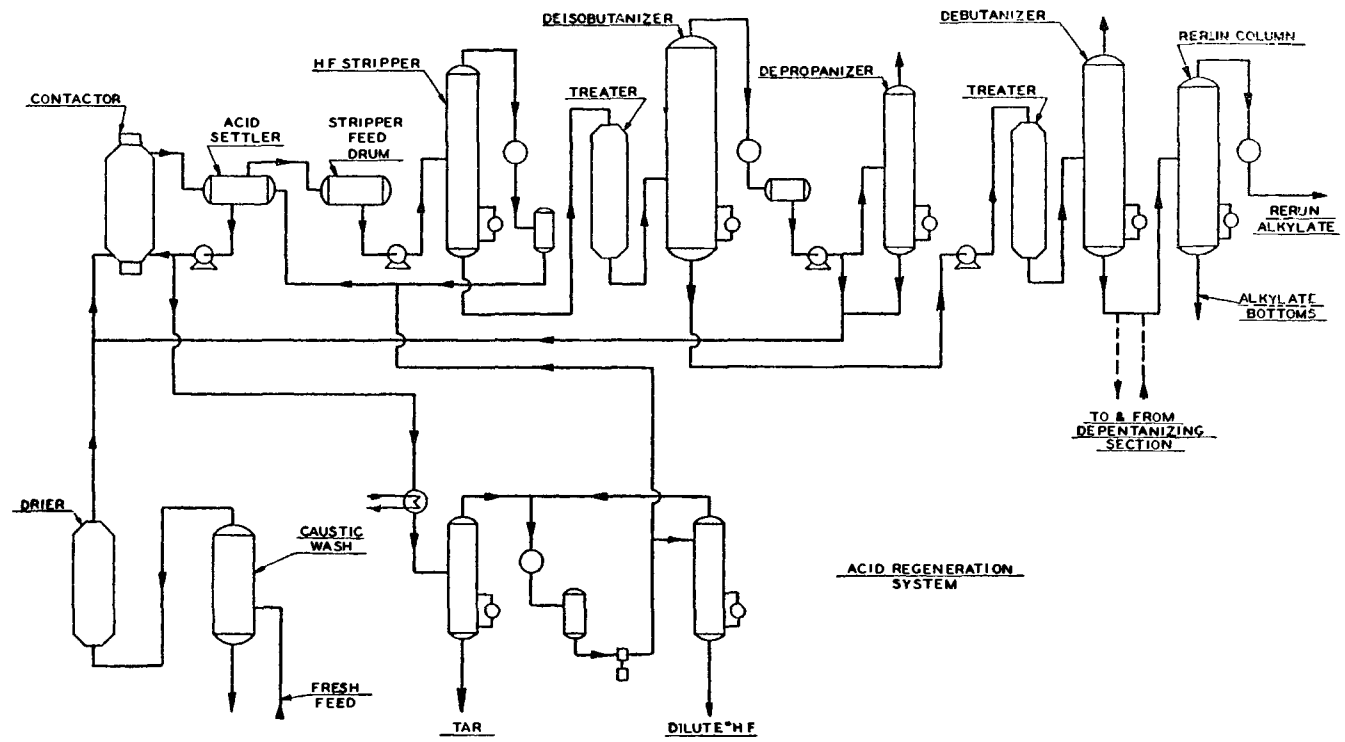

Fig. 4. Typical hydrogen fluoride alkylation unit

purified of high-boiling organic contaminants. The few per cent of such organic compounds remaining in the recycle acid have minimized the decomposition of primary alkylate; an excess of organic contaminants in the recycle acid would cause a production of organic fluorides instead of hydrocarbon products. A titratable acidity of 85–90 per cent has been usually maintained in the catalyst phase. The consumption of hydrogen fluoride in the form of physical and chemical losses has been kept at a rather low value.

2. Alkyl fluorides

Alkylation of isoalkanes by alkyl fluorides in the presence of anhydrous hydrogen fluoride (34) gives products similar to those obtained from the interaction of isoalkanes, alkenes, and hydrogen fluoride. The reaction is less exothermic and the products contain only traces of organic fluorides. Table 10 gives the ex-

TABLE 10
Alkylation of isoalkanes with alkyl fluorides in presence of hydrogen fluoride
(Linn)

Reactants used, grams:			
Isobutane.....	331	335	0
Isopentane.....	0	0	112
Isopropyl fluoride.....	106	0	79
<i>sec</i> -Butyl fluoride.....	0	121	0
Temperature of experiment, °C.....	37	10	35
Liquid alkanes recovered, grams:			
C ₅ and higher.....	163	184	
C ₆ and higher.....			132
Weight per cent fluorine.....	0.01	0.015	0.1
Composition of product, weight per cent:			
C ₅ alkanes.....	6	5.9	
C ₆ alkanes.....	7	4.3	12
C ₇ alkanes.....	41	3.6	10
C ₈ alkanes.....	29	67.8	23
C ₉ alkanes.....	4	18.4	13
Higher alkanes.....	13		42

perimental results for batch operation, using isobutane with isopropyl fluoride or *sec*-butyl fluoride and isopentane with isopropyl fluoride. No significant difference in composition of products from the interaction of isobutane with *sec*-butyl fluoride or 2-butene was found by infrared analysis.

H. SULFURIC ACID

No alkylation of an alkane or isoalkane by ethene in the presence of sulfuric acid has been reported. One group of investigators writes (54): "It was observed that ethylene and the normal paraffins are not appropriate materials for the condensation reaction at atmospheric pressure with sulfuric acid as a catalyst (in these series of experiments 98% sulfuric acid was always used)." This may be due to stability of normal alkanes, ethyl hydrogen sulfate, and diethyl sulfate at the usual alkylation temperatures.

TABLE 11

Diisobutene and isobutane at 20°C., using 96.9 per cent acid
Time of addition, 90 min.; time of stirring, 30 min.

RUN NO.	ISOBUTANE: DIISOBUTENE RATIO	PRODUCT >27°C.														PRODUCT 27-185°C.					RESIDUE					
		A. S. T. M. Distillation														On alkene taken			Bromine number†		Specific gravity at 15.6°C.		Octane rating			
		On alkene taken																					50% in H.O.S.§	Unleaded	+1.5 cc. T.E.L. per (Imperial) gallon	On alkene taken
		per cent	I.B.P. °C.	2%	5%	10%	20%	30%	40%	50%	60%	70%	80%	90%	F.B.P. °C.	T.D.	Residue	per cent	per cent	per cent	per cent	per cent				
42A	1:1	165	38	45.5	53	66.5	94	105	112.5	117.5	125.5	137.5	160.5	197	257	97.5	1.5	136	<1	0.705	71.2	90.5	98	22	14	0.783
51*	1:1	167	35.5	50	63.5	78.5	98.5	108	114.5	120.5	128.5	140	165	200	264.5	97.5	1.5	142	<1	0.701	71.6	90.8	99.2	19.6	10	0.782
55	2:1	184	33	39	49	64	89	101	107	112	118.5	128	148	194	230	96.5	1	158	<1	0.700	71.1	91.3	98.9	14.8	9.5	0.782
59	4:1	190†	36.5	55	68	81	96.5	103	107	110.5	114.5	120	133.5	172	220	97.5	1.5	167¶	<1	0.705	72.3	92.2	101	10.8	10	0.777

* Repeat run with improved stirrer.

† An engine test on the product boiling over 27°C. (i.e., including the residue) gave 90.6 octane number and 1.5 cc. T.E.L. per Imperial gallon 100 octane number.

‡ Francis method.

§ High-octane standard. A straight-run Iranian cut of 52.5 octane number.

¶ Sulfur, 0.01 per cent.

Birch, Dunstan, Fidler, Pim, and Tait were the first to publish a study on the alkylation of isobutane, isopentane, and 2-methylpentane by alkenes at 20°C. in the presence of 97 per cent sulfuric acid, emphasizing the isoalkane character of the products boiling from 27° to 185°C. and also their value as high-octane-rating motor fuels (9). Propene, however, reacted only when used with sulfuric acid of 100.6 per cent concentration, forming (at 30°C.) an 82.5-octane-rating fuel and a residue with 2.5 bromine number (Francis). Isobutane did not react with 1-butene as readily as with 2-butene, though the quality and quantity of hydrocarbons formed were comparable. With 2-butene it gave a considerable quantity of 2,2,4-trimethylpentane. Isobutene and its polymers (diisobutene and triisobutene) were observed to give "identical products" in the alkylation of isobutane. Apparently a depolymerization of the polyisobutenes occurs under

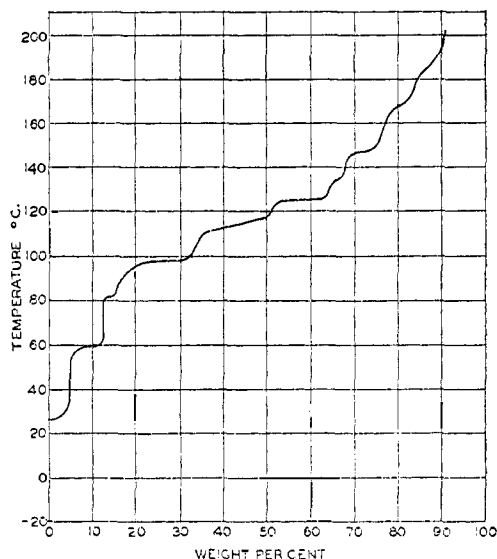

FIG. 5. Distillation curve (25-plate column) of product from diisobutene and isobutane at 20°C. $(C_4H_8)_2:C_4H_{10} = 1:2$. Run 59. (Birch, Dunstan, Fidler, Pim, and Tait)

reaction conditions. (We shall enclose the word "isobutene" in quotation marks whenever, owing to interchangeability of isobutene and its polymers in alkylation, the source of isobutene is considered to be inadequately disclosed in the literature.) The common product was found to contain isopentane, 2,3-dimethylbutane, 2,3- and 2,4-dimethylpentanes, 2,5-dimethylhexane, 2,2,4-trimethylpentane, and 2,2,5-trimethylhexane. An *excess of isobutane* over that required for equimolecular proportions of isobutane to "isobutene" led to an increased yield of motor fuel at the expense of high-boiling residue. Such motor fuel had an increased content of isoöctanes and showed a definite improvement in octane rating (table 11 and figure 5). The product from isobutane and "isobutene" in 4:1 ratio had a final boiling point of 220°C. and 90.6 octane rating; addition of 1.5 cc. of tetraethyllead per Imperial gallon gave a fuel with 100.0 octane number.

Other tests with isobutane and "isobutene" at -10°C . showed a drop in motor fuel yield, a slight improvement in octane rating, and the formation of a considerable amount of high-boiling residue. At temperatures above 20°C . an oxidation developed at the expense of sulfuric acid, which was "fouled" and reduced to sulfur dioxide. The hydrocarbon product showed a slightly decreased octane rating. Consequently, the optimum temperature point was considered to be 20°C .

Isobutane was also alkylated by refinery unsaturated C_4 fractions, 2-methyl-2-butene, butene-isobutene copolymers of $95-120^{\circ}\text{C}$. or $105.5-112^{\circ}\text{C}$. boiling range, and polymer gasoline ($80-120^{\circ}\text{C}$. boiling range; prepared from C_3 and C_4 alkenes). Refinery unsaturated cuts, consisting of all C_4 alkanes-alkenes and some butadiene, yielded a high-octane-rating motor fuel when reacted with an excess of isobutane. The polymer of $105.5-112^{\circ}\text{C}$. boiling range was found to alkylate isobutane at 20°C . in the presence of 97 per cent sulfuric acid, though the yield and octane rating of the motor fuel fraction were slightly low. Satisfactory results were obtained with polymer of $95-120^{\circ}\text{C}$. boiling range; the product closely resembled those from isobutane and polyisobutene, from isobutane and 1-butene, or from isobutane and 2-butene. Alkylations of isopentane and 2-methylpentane were similarly effected at 20°C . by contact with diisobutene and 97 per cent sulfuric acid. Table 12 summarizes most of the foregoing experiments. The product yields are based upon the weight of alkene taken. Thus the theoretical yield for the alkylation of isobutane by diisobutene is 204 per cent. Isooctane (2,2,4-trimethylpentane), which contains a tertiary carbon atom, failed to undergo alkylation.

Alkylation of isopentane by means of 2-methyl-2-butene and 98 per cent sulfuric acid has been investigated (54). A small amount of 2-methyl-1-butene was probably present in the 2-methyl-2-butene. The investigators dropped a mixture of the isoalkane and alkene into sulfuric acid maintained at $0-9^{\circ}\text{C}$. Two experiments were conducted, using 3:1 and 1:1 volume ratios of isoalkane and alkene and reaction times of 22-40 min.

With the 3:1 ratio of isopentane to 2-methyl-2-butene, the product consisted essentially of isoalkanes, including isobutane, an isohexane, an isononane, and the expected decane fraction. The high-boiling fractions were slightly unsaturated and probably non-cyclic in structure. A very good yield of products with a molecular weight higher than that of the raw materials was obtained (see table 13 and figure 6). The investigators explained their results as "a primary condensation of the olefinic and paraffinic part of the raw material, followed by a partial destruction of the condensation product into (a) paraffin(s) and (an) olefin(s) with different numbers of carbon atoms per molecule. The molecules formed in this way can react again with other saturated and unsaturated components of the reaction mixture."

With 1:1 ratio of isopentane to 2-methyl-2-butene, the formation of lower alkanes was competitive with a polymerization of the alkene into higher alkenes (table 14). The total yield of hydrocarbons was low. Decrease in the proportion of isopentane in the reaction mixture was considered, therefore, to be very

TABLE 12
 Summary of runs carried out in lead-lined autoclave with equimolecular ratios of isoalkane to alkene
 Temperature, 20 C.; time of addition, 90 min.; time of agitation, 30 min.
 (Birch, Dunstan, Fidler, Pim, and Tait)

RUN NO.	REACTANTS		CONCENTRATION OF H ₂ SO ₄	YIELD PER CENT OF MATERIAL >27°C. ON ALKENE TAKEN	PRODUCT 27-185°C.					RESIDUE		
	Isoalkane	Alkene			On alkene taken	Specific gravity at 15.6°C.	Bromine number (Francis)	Octane rating		On alkene taken	Specific gravity at 15.6°C.	Bromine number (Francis)
								Un-leaded	+1.5 cc. T.E.L. per (Imperial) gallon			
42A	Isobutane	Diisobutene	<i>per cent</i> 96.9	165	<i>per cent</i> 136	0.705	<1	90.5	98	<i>per cent</i> 22	0.783	14
30 } 49 }	Isobutane	Triisobutene	96.9	163	138	0.704	<1	88.7	98.9	20.5	0.782	3.5
63	Isobutane	B.I.B. (105.5-112°C.)	97	158	135	0.707	<1	87.0	97.9	20	0.784	15
71	Isobutane	B.I.B. (95-120°C.)	97	164	137	0.703	<1	89.4	99.5	22.9	0.7815	14
26	Isobutane	Polymer gasoline (80-120°C.)	97					84.6	95.5 (+2 cc.)			
40	Isobutane	Propene*	100.6	150	122	0.698	<1	82.5	93.3	23	0.774	2.5
62	Isobutane	2-Butene	97	164	148	0.706	<1	90.2	100.3	14.8	0.785	10
97	Isobutane	1-Butene	97	159	139	0.708	2	89.1	98.1†	20.5		
73	Isobutane	Trimethylethene	97	152	121.5	0.706	1	86.1	98.5	26.5	0.786	19
77	Isopentane	Diisobutene†	97	159	120	0.712	<1	79.7	90.4	38.4	0.787	23
56	Isohexane (2-methylpentane)	Diisobutene	97	217 (after removal of unchanged isoalkane)	159.5	0.6955	<1	77.6		54.3	0.785	20

* Temperature, 30°C.

† The product was cut at 40° instead of 27° in order to remove *n*-pentane, originally present as impurity in isopentane.

‡ 1.0 cc. T.E.L. per Imperial gallon.

unfavorable for alkylation to isodecanes. The investigators pointed out that Birch, Dunstan, Fidler, Pim, and Tait (9) obtained much better results with a 1:1 ratio of isoalkane to alkene than those just described. This was ascribed to the manner in which the latter carried out their experiments, by dropping the alkene into a mixture of sulfuric acid and a great excess of isoalkane.

In a further study of the sulfuric acid-catalyzed alkylation, it was reported that isobutane in excess and propene gave a product consisting mainly of 2,3- and 2,4-dimethylpentanes and an appreciable quantity of 2,2,4-trimethyl-

TABLE 13
Experiment with 3 volumes of isopentane and 1 volume of "trimethylethene"
(Waterman, Leendertse, and Hesselink)

BOILING POINT °C.	YIELD (PER CENT BY WEIGHT TO THE OLEFINIC RAW MATERIAL)	n_D^{20}	d_4^{20}	$\frac{n^2 - 1}{n^2 + 2} \cdot \frac{1}{d}$	MOLECULAR WEIGHT (C ₆ H ₈)	BROMINE VALUE		ANILINE POINT °C.
						(a)	(b)	
16.8- 23.8	38	1.3510			73	0	0	
23.8- 26.8	30	1.3514			72	0	0	
26.8- 33.0	87	1.3540			72	0	0	
33.0- 55	9							
55 - 63	17	1.3760	0.6567	0.3494	87	0	0	
63 -115	12							
115 -148	73	1.4058	0.7190	0.3415	139	0	0	81.0
50 - 66 (16 mm.)	28	1.4150	0.7377	0.3394	156	0	0	82.5
66 - 90 (14 mm.)	20	1.4199	0.7457	0.3393	168	1	1	84.9
90 -120 (14 mm.)	18	1.4291	0.7663	0.3365	199	1	8	90.9
120 -140 (14 mm.)	9	1.4419	0.7891	0.3353	243	1	33	95.2*
>140 (14 mm.)	10	1.4578	0.8170	0.3339	333	1	57	102.4†

(a) McIlhiney method: total quantity of bromine consumed by the hydrocarbon mixture minus twice the quantity of bromine found in the reaction mixture in the form of acid after the reaction.

(b) Total quantity of bromine consumed by the hydrocarbon mixture without subtracting the acid titration.

* Read from graph for saturated compounds (for $r_D^{20} = 0.3353$ and molecular weight = 243): 97°C.

† Read from graph for saturated compounds (for $r_D^{20} = 0.3339$ and molecular weight = 333): 111°C.

pentane (7). Constant presence of the last hydrocarbon in the products from interaction of isobutane with 1-butene, 2-butene, or isobutene was explained on the basis of a probable isomerization of the *n*-butenes into isobutene prior to addition of the isoalkane. A less probable "rearrangement" (isomerization) of an intermediate addition product was also mentioned. The main products from the reaction of isobutane with isobutene or its lower polymers were 2,2,4-trimethylpentane and isomeric octanes, probably 2,4- and 2,5-dimethylhexanes plus 2,3,3- and 2,3,4-trimethylpentanes. Lesser products included isopentane, 2,3-dimethylbutane, 2,3- and 2,4-dimethylpentanes, 2,2,5-trimethylhexane, and probably both 2-methylpentane and 2,2,6-trimethylheptane.

The effect of *n*-butane in appreciable amounts as a diluent in isobutane-diisobutene alkylation was to lower slightly the yield of gasoline fraction boiling to 185°C. when equimolecular ratios of isoalkane to "isobutene" were used. This phenomenon is shown in table 15.

The heat of reaction in typical alkylations of isobutane catalyzed by sulfuric acid of 97.9 per cent concentration is given in table 16. An order of accuracy estimated at ± 10 per cent has been placed upon the heat of reaction figures.

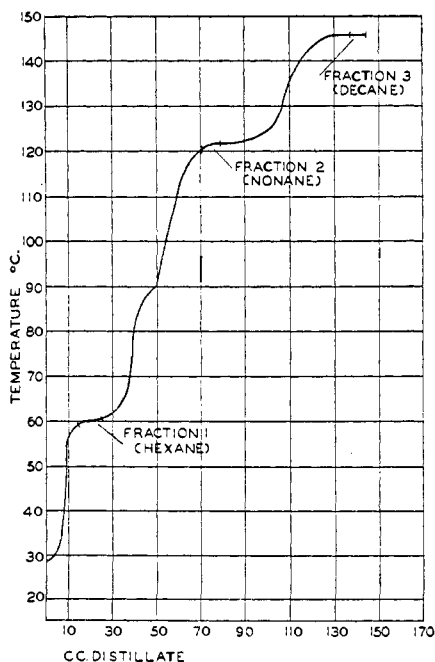

FIG. 6. Distillation of 200 cc. of a mixture of the fractions with boiling point 33°C. (at 760 mm.) to 66°C. (at 16 mm.) from experiment 1:

FRACTION	n_D^{20}	d_4^{20}	MOLECULAR WEIGHT (C ₆ H ₆)
1	1.3745	0.6575	87
2	1.4009	0.7079	125
3	1.4115	0.7305	138

From Waterman, Leendertse, and Hesselink.

Acid requirements to produce a definite quantity of saturated gasoline with 90+ octane rating were also considered. The conversion was considered to be no longer economical when repeated use of the acid lowers its concentration to approximately 82 per cent, corresponding to an over-all gasoline yield of 310-314 per cent by weight on the acid used. Beyond this point polymerization of the alkene replaces its function in alkylation. Addition of water to the sulfuric acid after reaction leads to the separation of highly unsaturated high-boiling

TABLE 14
Experiment with 1 volume of isopentane and 1 volume of "trimethylethene"
 (Waterman, Leendertse, and Hesselink)

BOILING POINT °C.	YIELD (PER CENT BY WEIGHT TO THE OLEFINIC RAW MATERIAL)	n_D^{20}	d_4^{20}	$\frac{n^2 - 1}{n^2 + 2} \frac{1}{d}$	MOLECULAR WEIGHT (C ₆ H ₆)	BROMINE VALUE		ANILINE POINT °C.
						(a)	(b)	
19 - 27.4	22	1.3505			72	0	0	
27.4- 45	28	1.3562			79	0	0	
45 -120	12	1.3892	0.6872	0.3443	110	0	0	75.8
120 -150	19	1.4058	0.7185	0.3417	128	0	0	80.1
55 - 70 (17 mm.)	14	1.4154	0.7390	0.3391	157	1	5	81.8
70 -103 (17 mm.)	10	1.4252	0.7557	0.3385	179	4	21	84.6
103 -125 (17 mm.)	12	1.4345	0.7718	0.3377	205	6	42	87.2
125 -150 (17 mm.)	13	1.4438	0.7878	0.3370	238	8	61	90.0*
150 -175 (17 mm.)	14	1.4515	0.8044	0.3351	286	7	66	94.2†
>175 (17 mm.)	16	1.4598	0.8200	0.3339	363	3	69	102.8‡

(a) McIlhiney method: total quantity of bromine consumed by the hydrocarbon mixture minus twice the quantity of bromine found in the reaction mixture in the form of acid after the reaction.

(b) Total quantity of bromine consumed by the hydrocarbon mixture without subtracting the acid titration.

* Read from graph for saturated compounds (for $r_D^{20} = 0.3370$ and molecular weight = 238): 98°C.

† Read from graph for saturated compounds (for $r_D^{20} = 0.3351$ and molecular weight = 286): 105°C.

‡ Read from graph for saturated compounds (for $r_D^{20} = 0.3339$ and molecular weight = 363): 115°C.

TABLE 15
Effect of n-butane on the isobutane and diisobutene reaction
 (Birch, Dunstan, Fidler, Pim, and Tait)

RUN NO.	ISOBUTANE CONTENT, PER CENT OF FEED ALKANES	RATIO OF ISOBUTANE TO DIISOBUTENE	PER CENT BASED ON DIISOBUTENE TAKEN	
			Gasoline (b.p. 27-185°C.)	Residue (b.p. >185°C.)
95	45	2:1	134	22.5
94	71		133	20.2
51	98		142	19.6
101	45	4.5:1	158	12.2
55	98		4:1	158
103	71	6:1	166	8.1
*	98		165	10

* These figures are interpolated from runs using isobutane:diisobutene ratios of 4:1 and 8:1.

hydrocarbons. These resemble the unsaturated oils formed along with hydro-polymers when alkenes are hydro-polymerized by sulfuric acid (31, 38, 39, 42).

The alkylation of isobutane by propene and that of isopentane by butenes were taken by Dunstan *et al.* (8) as reactions of most promise technically, giving excellent yields of high-octane-rating gasoline (table 17). Little or no addition of propene to isobutane occurred in the presence of sulfuric acid of 97 per cent initial concentration; formation of isopropylsulfuric esters and small amounts of the polymers and hydropolymers of propene resulted in its place. Dilution of the acid layer gave a small quantity of highly unsaturated oil. Acid of 100.6 or 101.7 per cent initial concentration led to the desired product, although the acid requirement was excessive. A temperature of 20°C. proved to be satisfactory. Best results were found for a 4:1 ratio of isobutane to propene; the product contained mainly 2,3- and 2,4-dimethylpentanes, besides 2,3-dimethylbutane, 2,2,4-trimethylpentane, and other isoöctanes. An interaction between isobutane and diisopropyl sulfate in the presence of concentrated sulfuric acid at

TABLE 16
Heat of reaction
(Birch, Dunstan, Fidler, Pim, and Tait)

RUN NO.	ALKENE	RATIO OF ALKENE TO ISOBUTANE	HEAT EVOLVED	
			calories per gram of alkene	B.t.u. per pound of alkene
164	Isobutene*	1:3	284	512
64, 65	Diisobutene*	1:2	122	220
66	Triisobutene*	1:12	97	175
165, 166	Unsaturated C ₄ fraction† from high-pressure crack- ing operation; total un- saturated content, 56 per cent	1:3	342	615

* The isobutane used for these reactions contained 98 per cent of isobutane.

† An isobutane concentrate containing 67 per cent of isobutane was used.

-12°C. was also observed. The product in one case had a boiling range of 88-244°C. and a bromine number (Francis) of less than 1.

Table 17 also has data on alkylations of isopentane by propene, 2-butene, and diisobutene. The reaction of isopentane with propene and 101.7 per cent sulfuric acid led to a good yield of a saturated gasoline having only a 73-octane rating. Among the identified hydrocarbons were isohexanes (2,3-dimethylbutane and probably both 2- and 3-methylpentanes) and isoöctanes (probably 2,3-, 2,4-, and 2,5-dimethylhexanes). Isopentane was found to react better with 2-butene than with diisobutene, yielding more gasoline. The gasoline had an improved volatility, higher octane rating, and a greater proportion of isononanes. It apparently contained 2-methylpentane, 2,3-dimethylbutane, much 2,2,5-trimethylhexane, and 2,2,6-trimethylheptane. Isopentane and diisobutene in 8:1 ratio gave an 82.7-octane-rating gasoline consisting mainly of C₆ to C₁₀ isoalkanes, including both 2,3-dimethylbutane and 2,2,4-trimethylpentane and probably also 2- and 3-methylpentanes, 2,4-dimethylpentane, 3-methylhexane, 2,2,5-trimethylhexane, and 2,2,6-trimethylheptane.

Another group of investigators (37) has studied (a) the alkylation of isobutane, isopentane, "isohexane" (2- and 3-methylpentanes), and 2,2-dimethylbutane as effected by sulfuric acid and a common alkene, i.e., 2-butene, and (b) similar reactions of isobutane, as a common alkane, with propene, 2-butene, isobutene, 2-pentene, 2-methyl-2-butene, octenes from 2-ethyl-1-hexanol dehydration, 2-butene dimer fraction (U.O.P. Co. polymerization process), butene dimer (hot sulfuric acid process), propene trimer (U.O.P. Co. polymerization process), diisoamylene, and butene trimer (hot sulfuric acid process). The results are summarized in tables 18-19.

Table 18 gives data on the alkylation of representative branched hydrocarbons by 2-butene. It indicates that the activity of isoalkanes decreased as the chain length increased, based upon the amount of alkylate produced per unit volume of acid. The octane rating of the alkylates likewise decreased. In the case of isopentane and 2-butene the product contained isobutane, 2-methylpentane (rather than 2,3-dimethylbutane), nonanes (probably 2,2,5-trimethylhexane and a dimethylheptane), and decanes. No alkylation of 2,2-dimethylbutane by 2-butene occurred even with a contact time of 1 hr.

Table 19 contains data on the alkylation of isobutane by representative normal or branched-chain alkenes. It indicates that a much greater percentage of lighter-boiling hydrocarbons was formed from branched-chain alkenes than from normal alkenes. With a 2-pentene feed only 28 per cent of the product boiled below the nonane range, whereas 2-methyl-2-butene gave a product containing 50 per cent of hydrocarbons boiling below the nonanes.

Alkylation of isoalkanes by alkenes in the presence of sulfuric acid for the purpose of producing 100-octane-rating aviation gasoline is practiced commercially by a number of oil companies. Their efforts have included an investigation of the underlying principles, the type of equipment used, the conditions of operation, and the results obtained with representative feed stocks (2). Studies of the following operating variables were made: ratio of isobutane to alkene, concentration of alkene in feed, ratio of acid to hydrocarbon in the reaction zone, acid strength, contact time, agitation, and temperature. Presence of a large excess of isoalkane in the reaction zone was specified. This requirement was variously met by special features in plant design. The optimum temperature for alkylation with C_4 alkenes was stated to lie between 0°C . and 10°C . A contact time of 20-40 min. was indicated for the last case, but contact times as low as 5 min. have been used. Figure 7 is a diagram of a typical sulfuric acid alkylation unit (9a).

III. THERMAL ALKYLATION

A. ALKENES

Non-catalytic addition of alkanes to ethene was established by Frey and Hepp (18). A measured proportion of propane or isobutane was circulated through copper-lined steel tubes at pressures ranging from 2500 to 4700 psi and temperatures slightly above 500°C . Ethene was injected into the hydrocarbon stream in small portions, providing a steady, low concentration of the alkylating agent. Table 20 gives data on two tests with propane and one with isobutane.

TABLE 17
Summary of results
 (Birch, Dunstan, Fidler, Pim, and Tait)

Run No.....	40	202	73	203	77	201	231
Isoalkane.....	Isobutane	Isobutane	Isobutane	Isopentane	Isopentane	Isopentane	Isopentane
Weight taken, grams.....	1800	3240	1800	3200	2500	3520	1240
Alkene.....	Propene	Propene	Trimethyl- ethene	Propene	Diisobutene	Diisobutene	2-Butene
Weight taken, grams.....	1300	535	2100	450	1800	650	235
Isoalkane:alkene ratio.....	1:1	4:1	1:1	4:1	2:1	8:1	4:1
Acid volume, cc.....	1600	1600	1600	1600	1600	1600	1800
Free acid concentration:							
Start, per cent.....	100.6	101.7	97	101.7	97	97	97
End, per cent.....		92.4		92.0			95.6
Crude product:*							
Per cent on alkene taken.....	150	215	152	214	159	238†	242†
Specific gravity at 15.6°C.....	0.708	0.685	0.715	0.699	0.727	0.709	0.709
Bromine number (Francis).....	1	<1	4	<1	7	2	<1
A.S.T.M. distillation, °C.:							
Initial boiling point.....	43.5	42.5	39.5	44	51.5	48	54
2 per cent.....	59.5	55.5	51	60.5	68.5	59	72
5.....	69	64	61	71.5	81	67	82
10.....	80	73	75	81.5	94.5	76.5	90
20.....	90	83.5	99.5	95.5	112.5	91.5	104
30.....	96	87	114	105	123.5	107.5	114
40.....	101.5	89	122.5	110.5	132.5	119.5	120
50.....	109	90.5	132	114	144	129	126
60.....	122	92	142	118	156	138	128.5
70.....	145.5	95	153.5	122	170	147	132
80.....	169.5	101	176	130	193.5	158	138.5
90.....	200	129	221.5	157.5	241	177	155
Final boiling point.....	248	184	282.5	201	297	236	202

Gasoline:*							
Per cent on alkene taken.....	124	200 (to 162°C.)	121.5	205	120	216	221 (to 160°C.)
Specific gravity at 15.6°C.....	0.698	0.692	0.706	0.696	0.712	0.703	0.706
Bromine number (Francis).....	<1	<1	<1	<1	<1	<1	<1
Octane number (C. F. R. Motor Method):							
Unleaded.....	82.5	89.1	86.1	73.0	79.7	82.7	85.0
Plus 1 cc. tetraethyllead per Imperial gallon.....	93.3 (plus 1.5 cc.)	96.2	98.5 (plus 1.5 cc.)	83.5	90.4	91.1	95.2
Residue > 185°C.:							
Per cent on alkene taken.....	23	8.2 (>162°C.)	26.5	8.2	38.4	20	17.5 (>160°C.)
Specific gravity at 15.6°C.....	0.774	0.775	0.786	0.785	0.787	0.780	0.760
Bromine number (Francis).....	2.5	<1	19	5	23	8	1.5

* Boiling range dependent on isoalkane starting material.

† No explanation can be offered for these extremely high yields above theoretical. Careful fractionation of the product indicated the presence of not more than 2.5-3.0 per cent *n*-pentane.

Tables 21 and 22 give additional data on the composition of the liquid products produced in these runs.

Tables 20–22 show that ethene enters extensively into the alkylation of propane and isobutane. The liquid products from propane contained about 75 weight per cent of pentanes, consisting of about one-third *n*-pentane and two-thirds isopentane. About 10 per cent of heptanes was also present.

Isobutane and ethene gave a liquid product containing 56.9 weight per cent of hexanes, of which nearly 80 per cent was 2,2-dimethylbutane. The last-named hydrocarbon was pointed out as a desirable component of aviation fuel. The

TABLE 18
Alkylation of representative isoalkanes with 2-butene
(McAllister, Anderson, Ballard, and Ross)

ISOALKANE USED	ISOBUTANE	ISOPENTANE	ISOHEXANE (2- AND 3-METHYL PENTANES)	NEO- HEXANE*
Conditions:				
Mole ratio of isoalkane to alkene.....	5.0	5.1	5.5	2
Strength of acid, weight per cent H ₂ SO ₄	100.0	100.0	99.8	100.0
Volume ratio of acid to hydrocarbon.....	0.7	0.7	0.7	0.6
Temperature, °C.....	10	10	10	10
Contact time, minutes.....	20	20	20	60
Results:				
Volumes of alkylate per volume of acid.....	20	11	5	
Weight per cent yield of alkylate, based on alkene used.....	200	264	206	None
Per cent of aviation fraction (E.P. 150° C.) in alkylate after stabilizing from original isoalkane.....	93	83	78 (E.P., 165°C.)	
Bromine number of alkylate, grams per 100 cc.....	<1	<1	<1	
Octane number (A.S.T.M.-C.F.R.) of aviation fraction of alkylate.....	94	86.5	76.5	

* Batch experiments.

reaction of isobutane with ethene also was studied from the standpoint of effect of pressure and circulation *vs.* once-through conversion. Tables 23 and 24 indicate that a temperature of 520°C. and a pressure of 2500 psi led to a fairly extensive formation of hexanes and other alkanes, although considerable thermal decomposition was evident. Tables 23 to 25 demonstrate that the hexane fraction in once-through conversion of an isobutane and ethene mixture amounted to only about one-third of that formed in recirculation with thirty-two additions of ethene (experiment No. 231–5) under otherwise similar conditions. Once-through operation also decreased the amount of 2,2-dimethylbutane present in the hexane fraction. A greater proportion of high-boiling compounds (C₈

TABLE 19
Alkylation of isobutane with representative alkenes
 (McAllister, Anderson, Ballard, and Ross)

TYPE OF ALKENE USED.....	NORMAL			TERTIARY			ALKENE POLYMERS				
	Pro-pene	2-Bu-tene	2-Pentene	Isobu-tene	2-Methyl-2-butene	Octenes from 2-ethyl-1-hexanol	Propene trimer (U.O.P. Polymer)	Butene dimer (hot acid polymer)	Butene trimer (hot acid polymer)	2-Butene dimer (U.O.P.)	Diiso-amylene
Conditions:											
Mole ratio of isoalkane to alkene...	6.7	5.0	10.0	7.1	10.0	10.0	15.8	10.7	20.3	10.6	20
Acid strength used, weight per cent H ₂ SO ₄	98.0	100.0	98.0	98.2	98.0	98.0	100.0	98.0	100.0	97.8	100.0
Volume ratio of acid to hydrocarbon.....	0.7	0.7	0.7	0.7	0.7	0.7	0.7	0.7	0.7	0.7	1.0
Temperature, °C.....	30	10	10	20	10	10	20	10	10	10	10
Contact time, minutes.....	40	20	20	10	20	20	20	20	20	20	20
Results:											
Volumes of alkylate per volume of acid.....	6	20	15 (extrap.)	12.5	14 (extrap.)	14	10.5	15 (extrap.)	11	12.5 (extrap.)	14
Weight per cent yield of total alkylate, based on alkene.....	213	200	185	180	192	150	193	185	166	188	203
Per cent of aviation fraction (E.P. 150°C.) in total alkylate.....	90	93	92	81	86	75	93	83	77	83	78
Bromine number, grams per 100 cc. of aviation fraction.....	<1	<1	<1	<1	<1	<1	<1	<1	<1	<1	<1
Octane number (A.S.T.M.-C.F.R.) of aviation fraction of alkylate...	88.5	94.0	91.0	91.5	93.0		78.5	93.0	93.0	88.0	91.0

ALKYLATION OF ALKANES

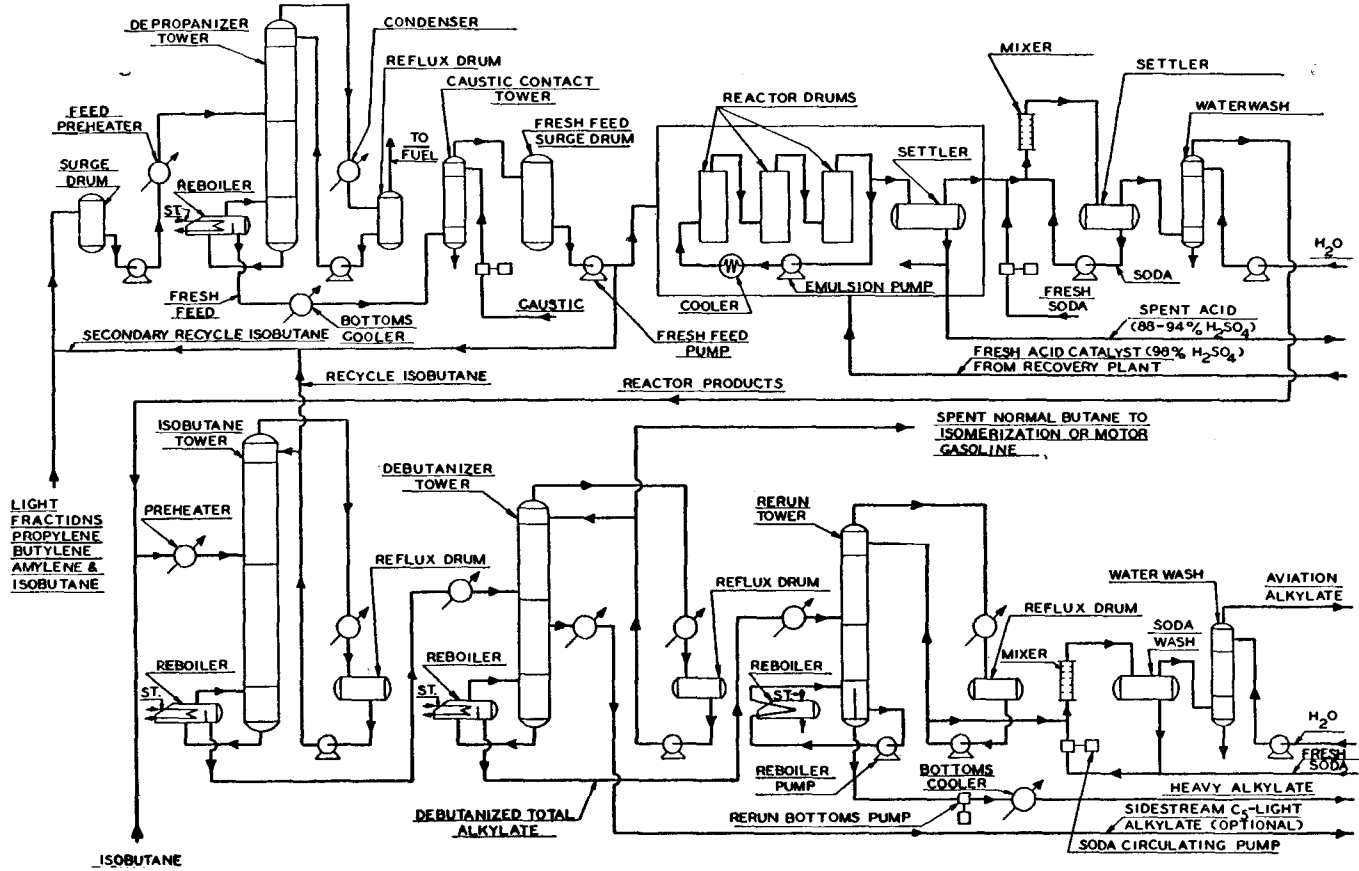

Fig. 7. Sulfuric acid alkylation process

TABLE 20
Products formed by interaction of alkanes and ethene under alkylation conditions
 (Frey and Hepp)

Experiment No.....	231-2		231-3		231-5	
Gases reacted, weight per cent.	{ C ₂ H ₄ , 4.7 C ₃ H ₈ , 95.3		{ C ₂ H ₄ , 8.9 C ₃ H ₈ , 91.1		{ C ₂ H ₄ , 12.1 Iso-C ₄ H ₁₀ , 87.9	
Pressure, psi.....	4500		4500		4500	
Temperature, °C.....	508		510		504	
Average reaction time of alkane reactant, minutes....	3.8		4.1		4.0	
Number of alkene additions...	40		20		32	
Gasoline yield based on products recovered, weight per cent.....	7.2		11.2		16.3	
	<i>weight per cent</i>	<i>mole per cent</i>	<i>weight per cent</i>	<i>mole per cent</i>	<i>weight per cent</i>	<i>mole per cent</i>
<i>Products recovered:</i>						
H ₂			0.004	0.09	0.013	0.39
CH ₄	*		0.72	2.09	0.94	3.30
C ₂ H ₄	1.77	2.87	1.23	2.07	1.68	3.54
C ₂ H ₆	0.34	0.64	0.53	0.81	0.81	1.59
C ₃ H ₆	0.16	0.21	0.16	0.17	0.56	0.78
C ₃ H ₈	89.59	91.29	84.40	86.60	2.09	2.77
Iso-C ₄ H ₈	} 0.39	} 0.32	0.21	0.18	0.30	0.31
1-C ₄ H ₈			0.80	0.67	0.34	0.35
2-C ₄ H ₈					0.11	0.12
Iso-C ₄ H ₁₀	0.0†		0.0†		76.34	75.60
n-C ₄ H ₁₀	0.55	0.42	0.70	0.54	0.54	0.54
C ₅ H ₁₀	0.18	0.11	0.29	0.19	0.81	0.67
Iso-C ₅ H ₁₂	3.76	2.33	6.20	4.00	0.53	0.44
n-C ₅ H ₁₂	1.67	1.04	1.87	1.18	0.80	0.65
C ₆ H ₁₂	0.12	0.07	0.22	0.12	0.49	0.34
2,2-Dimethylbutane.....	} 0.42	} 0.22	} 0.81	} 0.44	7.20	4.94
2-Methylpentane.....					1.88	1.29
n-Hexane.....					0.18	0.13
Intermediate alkenes.....					0.08	0.05
Intermediate alkanes.....					0.31	0.18
C ₇ H ₁₄			0.20	0.09	0.31	0.19
C ₇ H ₁₆			1.12	0.52	0.43	0.25
C ₈ H ₁₆			0.12	0.05	0.63	0.33
C ₈ H ₁₈			0.37	0.15	1.57	0.81
C ₉ and heavier:			0.10	0.04		
Unsaturated (alkenes)....	0.16	0.07‡			0.38	0.16
Saturated (alkanes).....	0.88	0.38			0.68	0.28
Total.....	100.00	100.00	100.00	100.00	100.00	100.00

* The methane determination was lost through an accident.

† Less than 10 per cent of the butanes.

‡ Heptanes and heavier.

and heavier) was found; these products were more cyclic than those from the recirculation experiment. The gasoline produced in once-through operation was considered to be chiefly alkanes. It was assumed that a rapid polymerization occurs in the initial stage of the reaction by reason of the high ethene concentration and that the alkene polymers alkylate isobutane into alkanes of higher

TABLE 21
Composition of liquid products from propane and ethene
(Frey and Hepp)

Experiment No.	231-2	231-3	231-3	231-3
Gases reacted, weight per cent:				
C ₂ H ₄	4.7	8.9		
C ₃ H ₈	95.3	91.1		
Pressure, psi	4500	4500		
Temperature, °C.	508	510		
Average reaction time of alkane reactant, minutes	3.8	4.1		
Gasoline yield, weight per cent of reactants	7.2	11.2		
LIQUID PRODUCTS				
	Composition		Density at 25°C.	Refractive index at 20°C.
	<i>weight per cent</i>	<i>weight per cent</i>		
C ₅ H ₁₀	2.5	2.6	0.618	1.3551
Iso-C ₅ H ₁₂	52.4	55.5		
n-C ₅ H ₁₂	23.2	16.4	0.633	1.3597
C ₆ H ₁₂	1.7	2.0	0.677	1.3952
C ₆ H ₁₄	5.8	7.3		
C ₇ H ₁₄		1.8	0.706	1.3970
C ₇ H ₁₆		10.1		
C ₇ and heavier:				
Unsaturated	2.2			
Saturated	12.2			
C ₈ and above:				
Unsaturated		1.0	0.755	1.4203
Saturated		3.3		
Total	100.00	100.00		

molecular weight. However, cyclization and condensation also occurred, yielding aromatics, tar, and carbon.

In the initial stage of thermal alkylation, alkane-alkene and alkene-alkene junctures are rapid. At 500°C. and 5000 psi, 2 to 5 mole per cent of the ethene dispersed in "paraffin" is expected to follow such reactions as:

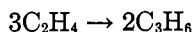
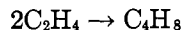

Because of the high partial pressure of the alkane used in such alkylations as $C_2H_4 + C_2H_6 \rightarrow C_4H_{10}$, these polymerizations would be surpassed by alkylation before attainment of thermodynamic equilibrium. Table 26, which is based on Kassel's calculations (32), indicates that at 500°C. a pressure of 5000 psi may be favorable for the alkylation of methane and ethane.

TABLE 22
Composition of liquid products from isobutane and ethene
(Frey and Hepp)

Test No.....	231-5		
Gases reacted, weight per cent:			
C ₂ H ₄	12.1		
Iso-C ₄ H ₁₀	87.9		
Pressure, psi.....	4500		
Temperature, C.....	505		
Average reaction time, minutes.....	4.0		
Gasoline yield, weight per cent of reactants.....	16.3		
Alkene in gasoline, per cent.....	16.1		
	GASOLINE		
	Composition	Density at 25°C.	Refractive index at 20°C.
	<i>weight per cent</i>		
Pentenes.....	4.97		
Isopentane.....	3.25		
<i>n</i> -Pentane.....	4.91		
Hexenes.....	3.01		
2,2-Dimethylbutane.....	44.26	0.645	1.3695
2-Methylpentane.....	11.55	0.655	1.3750
<i>n</i> -Hexane.....	1.11		
Heptenes.....	2.39		
Heptanes.....	4.54		
Octenes.....	3.87	0.714	1.3987
Octanes.....	9.64		
Residue:			
Unsaturated.....	2.33		
Unsaturated.....	4.17		
Total.....	100.00		

Additional data on the thermal alkylation of alkanes have been published (41). Table 27 gives the reaction conditions and analyses of total gaseous and liquid products for interactions of (1) ethene with propane or isobutane, (2) propene with propane, and (3) isobutene with isobutane. Analyses of the corresponding liquid products alone are given in table 28.

In table 27, experiments 2 and 5 represent a production of low-volatility alkylate from ethene with high conversion per pass; these tests meet the requirement of a greater output of gasoline from a given plant than is possible in the

synthesis of individual hydrocarbons such as 2,2-dimethylbutane. Table 28 indicates that ethene and propane yielded mainly isopentane and some *n*-pentane. Ethene with isobutane gave 2,2-dimethylbutane. Propane and propene

TABLE 23
Effect of pressure and single-point alkene addition on isobutane-ethene conversion
(Frey and Hepp)

Experiment No.....	266-11		266-12		231-5
Gases reacted, weight per cent:					
Ethene.....	16.5		9.8		12.1
Isobutane.....	83.5		90.2		87.9
Pressure, psi.....	4700		2500		4500
Temperature, °C.....	505		520		505
Average reaction time, minutes	5.1		4.3		4.0
Experimental method.....	Single-pass		Recirculation		Recirculation
Gasoline yield, weight per cent of effluents.....	20.4		12.8		16.1
<i>Products*:</i>	<i>mole per cent</i>	<i>weight per cent</i>	<i>mole per cent</i>	<i>weight per cent</i>	<i>weight per cent</i>
Hydrogen.....	3.48	2.34	1.28	0.05	0.013
Methane.....			10.35	3.09	0.94
Ethene.....	0.28	0.13	1.97	1.03	1.68
Ethane.....	5.14	2.68	4.64	2.62	0.81
Propene.....	1.05	0.76	2.21	1.72	0.56
Propane.....	3.83	2.98	3.71	3.12	2.09
Butene.....	2.35	2.26	2.22	2.32	0.75
Isobutane.....	66.14	67.97	65.35	72.53	76.34
<i>n</i> -Butane.....	0.44	0.45	0.64	0.71	0.54
Pentenes.....	0.73	0.89	0.56	0.73	0.81
Isopentane.....	0.53	0.68	0.48	0.66	0.53
<i>n</i> -Pentane.....	3.32	4.18	1.17	1.54	0.80
Hexenes.....	0.37	0.55	0.36	0.58	0.49
2,2-Dimethylbutane.....	0.72	1.08	1.98	3.22	7.20
Other hexanes.....	1.65	2.50	1.15	1.88	2.06
Heptenes.....	0.13	0.22	0.18	0.32	0.39
Heptanes.....	0.65	1.14	0.53	1.01	0.74
Octenes.....	0.35	0.69	0.21	0.50	0.63
Octanes.....	1.76	3.52	0.48	1.03	1.57
Nonanes +.....	1.79	4.19	0.29	0.71	1.06
Residue.....	0.29	0.79†	0.24	0.63	
Total.....	100.00	100.00	100.00	100.00	100.00

* The carbon-hydrogen ratio products in tests 266-11 and 266-12 is low. This factor is sensitive to small analytical errors and will not affect largely the conclusions drawn from the analyses shown.

† 0.15 weight per cent of carbon was found in test 266-11.

yielded 2-methylpentane and 2,3-dimethylbutane. *n*-Butane and ethene were stated to produce 3-methylpentane.

The foregoing investigators pointed out that thermal alkylation bears a gen-

eral resemblance to sulfuric acid alkylation, except that the catalytic action brings about reaction at ordinary temperatures and low pressures. A difference in charging stock characteristics was considered also (41):

“The two types of alkylation are markedly different in the way different individual paraffins and olefins respond. As to the olefins, acid alkylation reacts isobutylene, *n*-butenes, and propylene readily, and ethylene with difficulty. Thermal alkylation on the contrary reacts isobutylene with difficulty, *n*-butenes and propylene more readily, and

TABLE 24
Composition of liquid products from isobutane and ethene at 2500 psi
(Frey and Hepp)

Experiment No.....	266-12		
Gases reacted, weight per cent:			
Ethene.....	9.8		
Isobutane.....	90.2		
Pressure, psi.....	2500		
Temperature, °C.....	520		
Average reaction time, minutes.....	4.3		
Yield of liquid products (based on products recovered), weight per cent.....	12.8		
	LIQUID PRODUCTS		
	Composition	Yield	Density at 25°C.
	<i>mole per cent</i>	<i>weight per cent</i>	
Pentenes.....	7.3	5.7	0.652
Isopentane.....	6.3	5.2	
<i>n</i> -Pentane.....	15.3	12.0	
Hexenes.....	4.7	4.5	
2,2-Dimethylbutane.....	25.9	25.2	
Other hexanes.....	15.2	14.7	
Heptenes.....	2.4	2.5	0.714
Heptanes.....	6.9	7.9	
Octenes.....	2.8	3.9	
Octanes.....	6.3	8.0	0.741
Nonenes and heavier:			0.798
Unsaturated.....	2.0	2.9	
Saturated.....	3.3	5.0	
Residue.....	1.6	2.5	
Total.....	100.0	100.0	

ethylene most readily of all. As to the paraffins, acid alkylation is selective and limited to isoparaffins, the simplest of which are isobutane and isopentane, while thermal alkylation reacts these isoparaffins and normal paraffins with equal ease, *n*-pentane and *n*-butane reacting readily as well as propane. Ethane and methane, however, react with difficulty. In its application to gas polymerization, thermal alkylation furnishes a route for converting ethane, propane, and butane into motor fuel; ethane can be cracked or dehydrogenated to

ethylene which can be used to alkylate propane and butane in a second step. Propane or butane can also serve as an olefin source through cracking or catalytic dehydrogenation

TABLE 25
Composition of liquid products from isobutane and ethene
(Frey and Hepp)

Run No.	266-11	231-5
Charge stock, weight per cent:		
Ethene	16.5	12.1
Isobutane	83.5	87.9
Pressure, psi.....	4700	4500
Temperature, °C.....	505	504
Average reaction time, minutes	5.1	4.0
Experimental method.....	Single-pass	Recirculation
Yield of liquid products ..	20.4	16.3

LIQUID PRODUCTS

	Boiling range °C.	Composition		Density at 15.6°C.*	Refractive index at 20°C.	Composi- tion weight per cent	Density at 15.6°C.	Refractive index at 20°C.
		mole per cent	weight per cent					
Pentenes.....		5.94	4.35			4.97		
Isopentane....		4.31	3.32			3.25		
n-Pentane.....		27.00	20.48			4.91		
Hexenes.....		3.01	2.69			3.01		
2,2-Dimethyl- butane.....	47-52	5.86	5.28	0.667		44.26	0.652	1.3695
Other hexanes.	52-80	13.44	12.26	0.691		12.66	0.663	1.3750
Heptenes.....	80-93	1.06	1.08	0.709		2.39		
Heptanes.....		5.27	5.58		4.54			
Octenes.....	93-108	1.41	1.70	0.732	1.4108			
Octanes.....		8.78	10.51					
Octenes.....	108-117	0.58	0.70	0.746	1.4080	3.87	0.722	1.3987
Octanes.....		2.88	3.45			9.64		
Octenes.....	117-128	0.81	0.97	0.786	1.4305			
Octanes.....		2.73	3.27					
Nonenes +....	128-205	14.56	20.50	0.793	1.4416			
Nonanes +....								
Residue.....		2.36	3.86			6.50†		
Total.....		100.00	100.00			100.00		

* To convert to densities at 25°C., subtract 0.008.

† Residue boiling above 130°C. (C₉ and up).

“In combination with low-pressure cracking as a source of olefins, thermal alkylation constitutes a variant on the familiar two-stage principle, characterized by high yields and much flexibility in the use of feed stock. Ethane, propane, and butane occur together in natural gas or refinery gas and where their value as gaseous fuel is not too high, they can be exhaustively recovered and converted to produce, in such a situation, the maximum volume

of motor fuel by polymerization, by virtue of the nonselectivity of thermal alkylation with respect to conversion stock, without the addition of other conversion steps to the two-step process. Since ethane and also propane are ordinarily abundant as compared with butane in such situations, propane must be utilized in the alkylation step to make the volume of propane-butane more or less commensurate with the olefin derived from cracking ethane and the remainder of the propane. Under such circumstances the process is flexible with respect to reduction in available volume of butane. On the other hand, light straight-run or natural gasoline hydrocarbons in the normally liquid range can be included to effect reduction in volatility when desired."

A description has been given of a plant operated by Phillips Petroleum Company for the commercial production of 2,2-dimethylbutane, i.e., neohexane, from isobutane and ethene at 510°C. and 4500 psi in the alkylation coil (1). The desired temperature is easily maintained because higher temperatures bring about an endothermic cracking of isobutane. Carbon and tar formation are virtually eliminated by the high pressure used, leading to alkylation of the iso-

TABLE 26
Thermodynamic equilibria
(Frey and Hepp)

REACTION	LOG ₁₀ K (KASSEL)	K_p (500°C.)*	EXAMPLES†
(C ₄ H ₁₀)/(C ₂ H ₆)(C ₂ H ₄)	0.296 (700 K.) -0.602 (800 K.)	0.497	C ₂ H ₄ , 2.6; C ₂ H ₆ , 5.6; C ₄ H ₁₀ , 91.8
(C ₄ H ₁₀)/(CH ₄)(C ₃ H ₈)	-1.501 (700 K.) -2.215 (800 K.)	0.0832	C ₃ H ₈ , 5.1; CH ₄ , 16.7; C ₄ H ₁₀ , 78.2

* Computed from the values of Kassel, fugacity corrections applied.

† Compositions of equilibrium mixtures in weight per cent based on K_p values shown; pressure 5000 psi, temperature 500°C., alkene reactant 5 mole per cent of the equilibrium mixture.

butane. The ethene is slowly introduced into the reaction zone through several inlets distributed along the alkylation coil. Figure 8 is a flow diagram of the neohexane process.

B. METHYL RADICALS

An interesting transition between catalyzed and purely thermal types of alkylation of alkanes is provided in the work of Smith and Taylor (51). These investigators studied the reactions of methyl radicals (produced by photodecomposition of mercury dimethyl) with ethane, *n*-butane, isobutane, and 2,2-dimethylpropane in the temperature range 100-300°C. According to the theory given, each of the enumerated hydrocarbons (RH) is methylated by a mechanism involving a simultaneous formation of methane. Union of methyl radicals to form ethane is a competitive reaction:

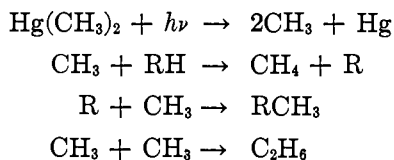

TABLE 27
*Products formed by interaction of alkanes and alkenes under alkylation conditions**
 (Oberfell and Frey)

Experiment No.....	1	2	3	4	5	6
Reactants, per cent.....	$\left\{ \begin{array}{l} \text{C}_2\text{H}_4, 8.9 \\ \text{C}_3\text{H}_8, 91.1 \end{array} \right.$	$\left\{ \begin{array}{l} \text{C}_2\text{H}_4, 25 \\ \text{C}_3\text{H}_8, 75 \end{array} \right.$	$\left\{ \begin{array}{l} \text{C}_3\text{H}_6, 12.8 \\ \text{C}_3\text{H}_8, 87.2 \end{array} \right.$	$\left\{ \begin{array}{l} \text{C}_2\text{H}_4, 11.8 \\ \text{Iso-C}_4\text{H}_{10}, 88.2 \end{array} \right.$	$\left\{ \begin{array}{l} \text{C}_2\text{H}_4, 25.6 \\ \text{Iso-C}_4\text{H}_{10}, 74.4 \end{array} \right.$	$\left\{ \begin{array}{l} \text{Iso-C}_4\text{H}_8, 8.2 \\ \text{Iso-C}_4\text{H}_{10}, 91.8 \end{array} \right.$
Pressure, psi.....	4500	4500	6300	4500	4500	8000
Temperature, °C.....	510	510	505	515	505	486
Total reaction time, minutes.....	4.1	5.6	7.4	2.2	4	3.2
Number of alkene additions.....	20	10	10	14	10	10
Gasoline yield based on total products.....	11.2	32.8	20.5	14.8	35.4	2.9
Analysis of products:						
H ₂	0.004	2.29	1.59	0.55	0.84	0.12
CH ₄	0.716					
C ₂ H ₄	1.23	0.69	0.09	1.72	2.30	0.05
C ₂ H ₆	0.53	4.10	2.64	0.71	1.44	0.04
C ₃ H ₆	0.16	0.88	2.05	0.60	0.63	0.19
C ₃ H ₈	84.40	54.17	69.29	0.76	2.04	0.05
Iso-C ₄ H ₈	0.21	1.92	$\left\{ \begin{array}{l} 0.89 \\ 0.85 \end{array} \right.$	2.04	0.98	4.10
n-C ₄ H ₈	0.80					
Iso-C ₄ H ₁₀	0.70	3.17	2.09	78.77	56.37	92.36
n-C ₄ H ₁₀						
C ₅ H ₁₀	0.29	1.24	1.01	0.29	0.78	0.20
Iso-C ₅ H ₁₂	6.20	9.38	1.36	0.73	$\left\{ \begin{array}{l} 1.11 \\ 0.97 \end{array} \right.$	0.11
n-C ₅ H ₁₂	1.82	4.22	1.79			
C ₆ H ₁₂	0.22	0.80	0.82	0.77	0.95	0.05
2,2-Dimethylbutane.....	0.81	3.67	0.56	2.60	11.10	0.08
2,3-Dimethylbutane.....			3.67			
2-Methylpentane.....			3.54			
n-Hexane.....			1.07			

C ₇ H ₁₄	0.20	0.76	0.54	0.36	0.71	0.10
C ₇ H ₁₆	1.12	3.60	1.74	0.61	1.45	1.13
C ₈ H ₁₆	0.12	0.62	0.50	0.47	1.03	1.01
C ₈ H ₁₈	0.37	1.95	1.23	1.89	4.84	1.05
C ₉₊ to 200°C.....	0.10	{ 3.46	2.68	0.72	6.14	0.36
Above 200°C.....						
Total.....	100.00	100.00	100.00	100.00	100.00	100.00

* All percentages are by weight.

TABLE 28
 Composition of liquid products* from table 27
 (Oberfell and Frey)

Experiment No.....	1	2	3	4	5	6
Reactants per cent.....	C ₂ H ₄ , 8.9 C ₃ H ₈ , 91.1	C ₂ H ₄ , 25 C ₃ H ₈ , 75	C ₂ H ₆ , 12.8 C ₃ H ₈ , 87.2	C ₂ H ₄ , 11.8 Iso-C ₄ H ₁₀ , 88.2	C ₂ H ₄ , 25.6 Iso-C ₄ H ₁₀ , 74.4	Iso-C ₄ H ₈ , 8.2 Iso-C ₄ H ₁₀ , 91.8
Analysis of liquid products:						
C ₅ H ₁₀	2.6	3.7	5.1	1.9	2.2	6.5
Iso-C ₅ H ₁₂	55.1	28.6	6.7	5.0	3.1	3.6
<i>n</i> -C ₅ H ₁₂	16.2	12.9	8.8	5.2	2.7	1.6
C ₆ H ₁₂	1.9	2.4	4.4	42.1	2.7	1.6
2,2-Dimethylbutane.....			2.7	17.5	31.3	2.6
2,3-Dimethylbutane.....			18.0			
2-Methylpentane.....	7.1	11.2	17.7		9.9	
<i>n</i> -Hexane.....			5.4			
C ₇ H ₁₄	1.8	2.3	2.4	2.4	2.0	3.2
C ₇ H ₁₆	10.0	11.0	7.9	4.1	4.1	4.2
C ₈ H ₁₈	1.0	1.9	2.4	3.2	2.9	32.7
C ₈ H ₁₈	3.3	6.0	6.2	12.7	13.7	34.0
C ₉₊ to 200°C.....	1.0	10.6	12.3	4.8	17.4	11.6
Heavier.....		9.4		1.1	8.0	
Total.....	100.0	100.0	100.0	100.0	100.0	100.0

* All percentages are by weight.

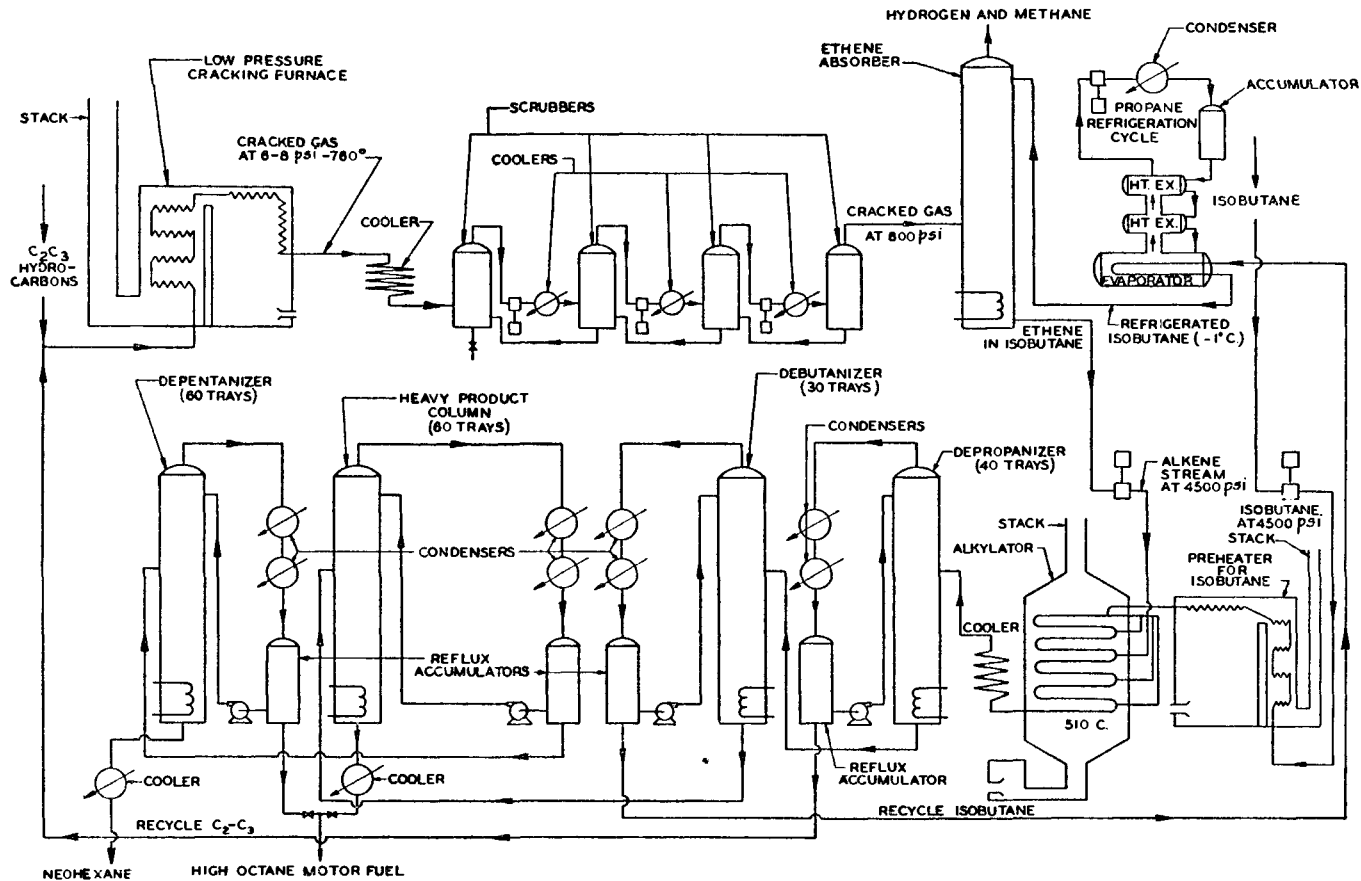

ALKYLATION OF ALKANES

FIG. 8. Flow diagram of neohexane process (Alden)

TABLE 29

Alkylation of straight-chain alkanes

REACTANTS	PROPANE + ETHENE	PROPANE + PROPENE	n-BUTANE + ETHENE	n-BUTANE + CH ₃ Br	n-BUTANE + C ₂ H ₅ Br	n-HEXANE + ETHENE
PROCESS OR CATALYST	Thermal	Thermal	Thermal	AlBr ₃	AlBr ₃	AlCl ₃
<i>Products observed:</i>						
C ₄ H ₁₀	+	+		+	+	
n-Butane	+					
Isobutane	+			+	+	
C ₅ H ₁₂	+	+		+		+
n-Pentane	+	+				
Isopentane	+	+		+		
C ₆ H ₁₄	+	+	+		+	+
n-Hexane		+				
2-Methylpentane		+				
3-Methylpentane			+			
2,2-Dimethylbutane		+				
2,3-Dimethylbutane		+				
C ₇ H ₁₆	+	+				+
C ₈ H ₁₈	+	+				+
C ₉ H ₂₀	?	?				?
C ₁₀ H ₂₂	?	?				?

TABLE 30

Alkylation of isobutane by C₁-C₃ alkylating agents

ALKYLATING AGENT	METHYL BRO- MIDE	ETHENE						ETHYL BRO- MIDE	PROPENE				ISO- PROPYL FLUO- RIDE						
		AlBr ₃	AlCl ₃	AlCl ₃ + HCl	NaAlCl ₄	Zr-Cl ₄	BF ₃ + H ₂ O		BF ₃ + HF + NI	Solid H ₃ PO ₄	Thermal	AlBr ₃		AlCl ₃ + HCl	LiAlCl ₄	NaAlCl ₄	BF ₃ + HF	HF	H ₂ SO ₄
<i>Products observed:</i>																			
C ₆ H ₁₂	+	+		+			+	+		+	+								+
n-Pentane																			
Isopentane	+	+																	
C ₆ H ₁₄	?	+	+	+	+	+	+	+	+	+	+							+	+
n-Hexane																			
2-Methylpentane			+				+	+	+	+	+								
2,2-Dimethylbutane			+				+	+	+	+	+								
2,3-Dimethylbutane			+				+	+	+	+	+								
C ₇ H ₁₆		+		+				+	+		+	+	+	+	+	+	+		+
2,3-Dimethylpentane																			
2,4-Dimethylpentane																			
C ₈ H ₁₈		+		+	+		+	+	+	?		+	+	+	+	+	+	+	+
2,2,4-Trimethylpentane																			
2,3,3-Trimethylpentane																			?
2,3,4-Trimethylpentane																			?
C ₉ H ₂₀		+		?								+	+	?					+
C ₁₀ H ₂₂		+			+							+	+						?
C ₁₁ H ₂₄		+																	

In the cases of *n*-butane and isobutane, saturated hydrocarbons with vapor pressures in the same range as that of mercury dimethyl were observed. The reaction products from 2, 2-dimethylpropane were similarly devoid of unsaturated hydrocarbons.

TABLE 31
Alkylation of isobutane by C₄ alkylating agents

ALKYLATING AGENT	1-BUTENE		2-BUTENE		<i>n</i> -BUTENES		sec-BUTYL FLUORIDE	ISOBUTENE				
	H ₂ SO ₄	HF	H ₂ SO ₄	AlCl ₃ + HCl	HF	HF	NaAlCl ₄	BF ₃ + HF + Ni	HF	H ₂ SO ₄	Thermal	
<i>Products observed:</i>												
C ₅ H ₁₂	+	+	+				+	+	?		+	+
Isopentane.....	+		+						?		+	
C ₆ H ₁₄	+	+	+				+	+	?		+	+
2-Methylpentane	+		+								?	
2,3-Dimethylbutane.....	+		+								+	
C ₇ H ₁₆		+					+	+	+		+	+
2,3-Dimethylpentane.....											+	
2,4-Dimethylpentane.....											+	
C ₈ H ₁₈	+	+	+	+	+		+	+	+	+	+	+
2,4-Dimethylhexane.....	+		+								?	
2,5-Dimethylhexane.....	+		+	+							+	
2,2,3-Trimethylpentane...				+								
2,2,4-Trimethylpentane...	+		+	+	+					+	+	
2,3,3-Trimethylpentane...			?								?	
2,3,4-Trimethylpentane...			?	+							?	
C ₉ H ₂₀	+	+	+				+	?	?		+	?
2,2,5-Trimethylhexane....	+		+								+	
C ₁₀ H ₂₂	?	?	?				?		?		?	
2,2,6-Trimethylheptane...	?		?								?	
C ₁₁ H ₂₄									?			
C ₁₂ H ₂₆				+					+			
Higher alkanes....									+			

IV. SUMMARY OF THE PRODUCTS OF ALKYLATION

Data on the composition of products obtained in the alkylation of alkanes by catalytic or thermal methods are summarized in tables 29-33. Table 29 covers alkylations of straight-chain alkanes by such alkylating agents as ethene

and ethyl bromide. It indicates that there are definite gaps in the experimental work, including no data for methane, ethane, and *n*-pentane as reactants. Table 30 summarizes alkylations of isobutane by lower alkenes or lower alkyl halides. The data indicate that a variety of catalysts have been utilized and that not even half of the products are identified. Table 31 has data on the alkylation of isobutane by C₄ alkylating agents, including butenes and *sec*-butyl fluoride. It indicates that a number of products remain to be identified defi-

TABLE 32

Alkylation of isobutane by C₅-C₁₂ alkylating agents in presence of sulfuric acid

ALKYLATING AGENT.....	2-PEN- TENE	2-ME- THYL-2- BUTENE	OCTENES FROM DE- HYDRATION OF 2-ETHYL- 1-HEXANOL	"BU- TENE DI- MERS"	DIISO- BUTENE	PRO- PENE TRIMERS	DIISO- AMY- LENE	"BU- TENE TRI- MERS"	TRIIISO- BUTENE
<i>Products obtained:</i>									
C ₅ H ₁₂	+	+	+	+	+	+	+	+	+
Isopentane.....	+	+	+	+	+	+	+	+	+
C ₆ H ₁₄		+	+	+	+	+	+	+	+
2-Methylpentane.....					+				?
2,3-Dimethylbutane.....		+	+	+	+	+	+	+	+
C ₇ H ₁₆					+				+
2,3-Dimethylpentane.....					+				+
2,4-Dimethylpentane.....					+				+
C ₈ H ₁₈	+	+	+	+	+	+	+	+	+
3-Methylheptane.....			+						
2,4-Dimethylhexane.....					+				?
2,5-Dimethylhexane.....					+				+
2,2,4-Trimethylpen- tane.....	+	+	+	+	+	+	+	+	+
2,3,3-Trimethylpen- tane.....	?	?	?	?		?	?	?	?
2,3,4-Trimethylpen- tane.....	?	?		?		?	?	?	?
C ₉ H ₂₀	+	+			+	+			+
2,2,5-Trimethylhex- ane.....					+				+
C ₁₀ H ₂₂					?		+		?
2,2,6-Trimethylhep- tane.....					?				?
C ₁₂ H ₂₆			?	?				+	

nately. The presence of 2,2,4-trimethylpentane among the products is known in six out of eleven instances. Table 32 covers the alkylation of isobutane by higher alkenes. In all cases the products include isopentane and 2,2,4-trimethylpentane. 2,3-Dimethylbutane is usually present also. Table 33 summarizes alkylations of isopentane and 2,2,4-trimethylpentane. The data indicate that the alkylation products have been analyzed incompletely. Hydrocarbon mix-

tures are now being analyzed by investigation of their infrared- and ultraviolet-absorption spectra, the Raman effect, and mass spectrographs. By previous methods the identification of alkanes was an exceedingly difficult task.

TABLE 33
Alkylations of isopentane and 2,2,4-trimethylpentane

REACTANTS.....	ISOPENTANE								2, 2, 4-TRI-METHYL-PENTANE + ETHENE
	Ethene	Propene		2-Bu-tene	<i>n</i> -Bu-tenes	2-Methyl-2-butene	Diiso-butene	Isopropyl fluoride	
CATALYSTS.....	BF ₃ + HF + Ni	HF	H ₂ SO ₄	H ₂ SO ₄	H ₂ SO ₄	H ₂ SO ₄	H ₂ SO ₄	HF	BF ₃ + HF + Ni
<i>Products observed:</i>									
C ₆ H ₁₄	+		+	+	+	+	+	+	
2-Methylpentane....			?	+	+		?		
3-Methylpentane....			?				?		
2,3-Dimethylbutane.			+	?	+		+		
C ₇ H ₁₆	+	+			+	?	?	+	
2-Methylhexane....					+				
3-Methylhexane....							?		
2,3-Dimethylpen-tane.....		+			+				
2,4-Dimethylpen-tane.....		+					?		
2,2,3-Trimethylbu-tane.....		+							
C ₈ H ₁₈	+	+	?			?	+	+	+
2,3-Dimethylhexane.		+	?						
2,4-Dimethylhexane.			?						
2,5-Dimethylhexane.		+	?						
2,2,4-Trimethylpen-tane.....							+		
C ₉ H ₂₀	+			+		+	?	+	
Dimethylheptane....				?					
2,2,5-Trimethylhex-ane.....				?			?		
C ₁₀ H ₂₂	+			+		+	?	?	+
2,2,6-Trimethylhep-tane.....				?			?		
C ₁₂ H ₂₆									+

V. MECHANISM OF ALKYLATION

A. CATALYTIC ALKYLATION

The first published mechanism for the alkylation of alkanes is that of Ipatieff and Grosse, who postulated a direct addition of an alkene to the tertiary carbon atom of an isoalkane in the presence of a catalyst (boron trifluoride, finely divided nickel, and small quantities of either water or hydrogen fluoride) (28). The possibility of a simultaneous isomerization and the occurrence of multiple alkyla-

tion were also mentioned. They illustrated their mechanism by the direct ethylation of isobutane to form 2,2-dimethylbutane:

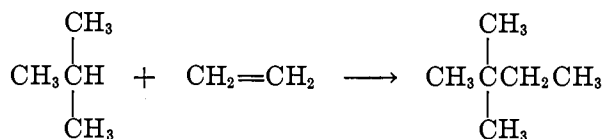

This mechanism was reconsidered in a later paper (20), wherein the hexanes produced from isobutane, ethene, and either boron trifluoride-nickel-hydrogen fluoride mixture or aluminum chloride were identified as 2-methylpentane (10-25 per cent), 2,2-dimethylbutane (<3 per cent), and 2,3-dimethylbutane (70-90 per cent). Isomerization of the 2,2-dimethylbutane was introduced therefore as an explanation of the abundant formation of 2,3-dimethylbutane and 2-methylpentane. Direct addition of ethene to a primary carbon atom of isobutane was given as an alternative explanation for the formation of 2-methylpentane.

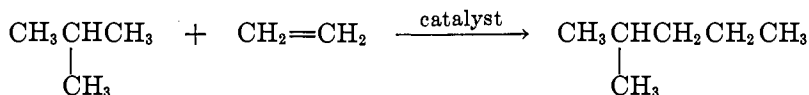

2-Methylpentane would thus be a primary product, owing to the greater availability (9:1) or more efficient catalytic activation of the primary C—H bond.

The rôle of aluminum chloride in the alkylation of isobutane by ethene was considered in still another paper (26). Isobutane was conceived as reacting probably with an aluminum chloride-ethene complex:

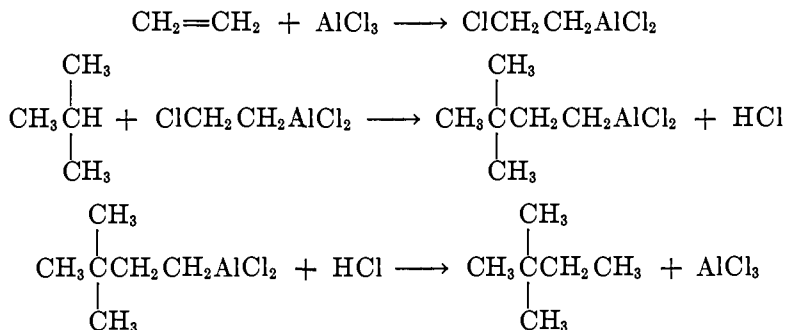

Isomerization of 2,2-dimethylbutane was considered to give 2,3-dimethylbutane.

In a similar manner, Pines, Grosse, and Ipatieff considered 2,2,3-trimethylpentane to be one of the primary products of the alkylation of isobutane by *n*-butenes (44):

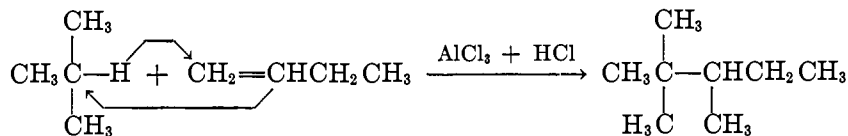

Isomerization of *n*-butenes into isobutene, followed by reaction with isobutane, was taken as the probable mechanism of formation of 2,5-dimethylhexane and 2,2,4-trimethylpentane:

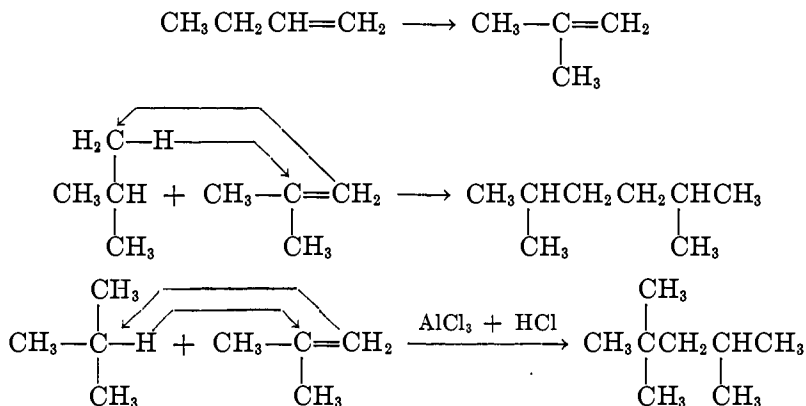

The presence of 2,3,4-trimethylpentane was explained on the basis of isomerization of the other octanes.

Heldman has pointed out the thermodynamic impossibility of an extensive isomerization of 2,2-dimethylbutane into 2,3-dimethylbutane (22). His opinion was based on the thermodynamic equilibria of Rossini, Prosen, and Pitzer (47). According to the last-named writers, the equilibrium concentrations of hexanes at 25°C. are theoretically 1.3 per cent of *n*-hexane, 7.1 per cent of 2-methylpentane, 2.5 per cent of 3-methylpentane, 84 per cent of 2,2-dimethylbutane, but only 5.4 per cent of 2,3-dimethylbutane. Even less 2,3-dimethylbutane should be present at temperatures below 25°C. A several-day isomerization of hexane over an undisclosed catalyst yielded *n*-hexane, 2-methylpentane, 3-methylpentane, 2,2-dimethylbutane, and 2,3-dimethylbutane in the proportions 4, 23, 10, 56, and 7 mole per cent for the liquid phase and 2, 18, 7, 67, and 6 mole per cent for the gas phase, respectively (32a). If the aforesaid isomerization and thermodynamic equilibria are accepted, then the amount of 2,2-dimethylbutane formed from isobutane and ethene under equilibrium conditions should be at least eight times the amount of 2,3-dimethylbutane. Evering, Fragen, and Weems indicate rapidly increasing amounts of 2,2-dimethylbutane with every drop in temperature from 204.4°C. to 21.1°C. in liquid-phase isomerization of hexanes (16a). Their experimental data for equilibrium conditions at 21.1°C. are 4 per cent of *n*-hexane, 20 per cent of 2-methylpentane, 8 per cent of 3-methylpentane, 57 per cent of 2,2-dimethylbutane, and 11 per cent of 2,3-dimethylbutane. It is probably true, however, that the time of alkylation of isobutane (10–22 hr.) was too short for the attainment of a state of equilibrium. The fact that *gem*-dimethyl structures are difficult to obtain in isomerization (15)—a result usually ascribed to steric hindrance—cannot be cited for or against the alkylation mechanism proposed by Ipatieff and Grosse (20, 26); *gem*-structured 2,2-dimethylbutane is their assumed primary product. In the *thermal* alkylation of isobutane by ethene, the principal hexane produced is 2,2-dimethylbutane.

Heldman has compared the alkylation (23) of alkanes by alkyl bromides in the presence of aluminum bromide, ostensibly (22) by RAlBr_4 , with an isomerization (22, 33) of alkanes by hydrogen aluminum bromide (HAlBr_4). The common group, AlBr_4^- , is provisionally (22) considered to be the true catalyst. He predicts (22, 23) an alkylation of light alkanes along with their isomerization when the isomerization promoter is methyl bromide or possibly ethyl bromide.

Birch, Dunstan, Fidler, Pim, and Tait have pointed out that the apparent mechanism of the alkylation of alkanes in the presence of sulfuric acid is alkylation at methyl groups (8):

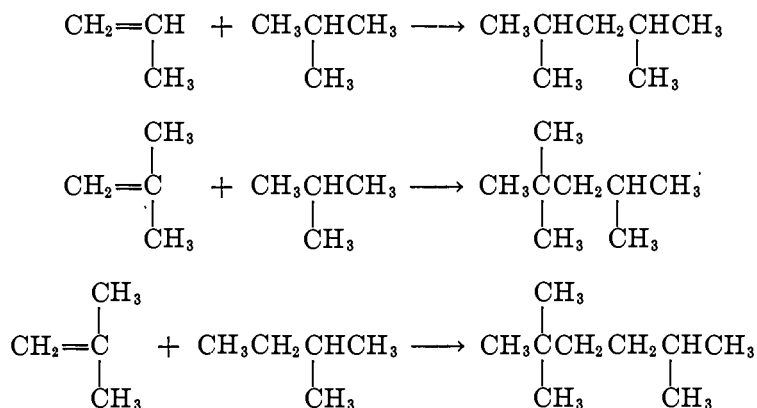

An addition of alkene to the secondary and tertiary carbon atoms of the alkane, followed by isomerization, was regarded as uncertain. The presence of 2,3-dimethylbutane in the products from every alkylation examined was also disclosed; this phenomenon was not explained.

Birch and Dunstan have assumed further (6) that the alkylation proper in the sulfuric acid-catalyzed interaction of isoalkanes and alkenes involves (a) the formation of an intermediate complex between the isoalkane and the acid, (b) the transfer of a proton from the sulfuric acid in the complex to an annexing alkene molecule, which makes the latter a positive alkyl group, (c) the transfer of a proton from a *methyl* group of the alkane in the complex to the hydrosulfate group, which operation forms a negative alkyl group, and (d) the union of positive and negative alkyl groups with liberation of free sulfuric acid. These steps were illustrated for the formation of 2,2,4-trimethylpentane from isobutane and isobutene:

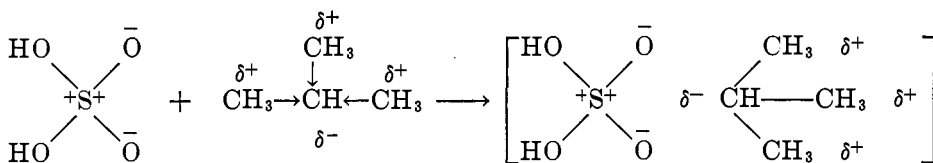

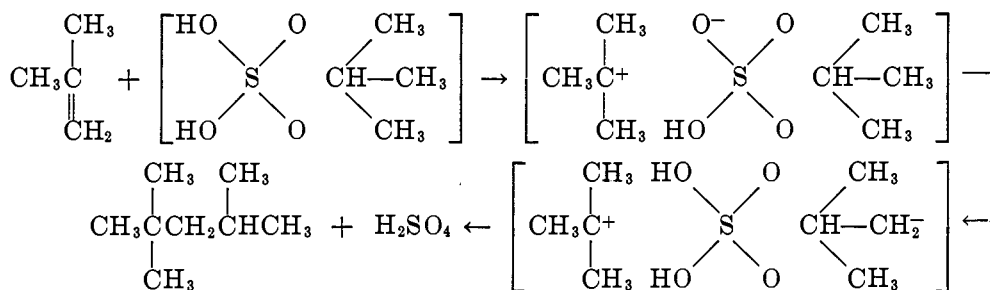

The electrical dipoles or formal charges associated with isobutane and its complex are those assigned by the investigators. Formation of a complex between isoalkane and sulfuric acid with the aid of dipole forces would thus be as essential as effective dispersion of the isoalkane in the acid for good yields of alkylate.

TABLE 34
Products formed in various isoalkane-alkene addition reactions
 (Birch and Dunstan)

ISOALKANE	ALKENE	MAIN PRODUCTS
Isobutane	Propene	2,4- and 2,3-dimethylpentanes; 2,2,4-trimethylpentane; 2,3-dimethylbutane
Isobutane	1-Butene 2-Butene Diisobutene	2,2,4-Trimethylpentane; 2,5- and 2,4-dimethylhexanes; 2,2,5-trimethylhexane; 2,3-dimethylbutane; 2-methylpentane; (2,2,6-trimethylheptane?); isopentane
Isopentane	Propene	2,3-, 2,4-, 2,5-Dimethylhexanes; isobutane
Isopentane	2-Butene Diisobutene	2,2,5-Trimethylhexane; isohexanes (probably mainly 2- and 3-methylpentanes); (2,2,6-trimethylheptane?)
2-Methylpentane	2-Butene Diisobutene	(2,2,6-Trimethylheptane?); isobutane; isopentane

Side reactions accompanying the alkylation proper are considered to include (6): (a) depolymerization of diisobutene, triisobutene, or butene-isobutene copolymers when these are used as reactants, (b) isomerization of initial alkene, (c) hydropolymerization of initial alkene into hydropolymers and dehydropolymers, (d) dehydrogenation of initial alkane into an alkene, (e) isomerization of isoalkane produced in the alkylation proper, and (f) degradation of primary products into alkanes and alkenes. Table 34 lists the main products formed when isobutane, isopentane, or 2-methylpentane react with alkenes in the presence of sulfuric acid.

An inspection of table 34 reveals the formation of many isoalkanes with less or more carbon atoms than for an alkylation. A depolymerization of diisobutene into isobutene and isomerizations of 1-butene and 2-butene into isobutene

were assumed to be operative, accounting for closely similar, if not identical products from isobutane in three cases, from isopentane in two cases, or from 2-methylpentane in two cases. It was suggested that the action of concentrated sulfuric acid upon 2,2,4-trimethylpentane causes a reversal of alkylation,



and that an observed darkening of the acid (brown coloration) is indicative of alkene formation. Other isoalkanes that were observed to break down in this way include 2,3-dimethylbutane, 2,2,3-trimethylpentane, 2,3,4-trimethylpentane, and 2,2,5-trimethylhexane. Isopentane, 2,2-dimethylbutane, and 2,2,3-trimethylbutane appeared to be unaffected by sulfuric acid; *n*-butane and diisobutene, also 2,2-dimethylbutane and 2-butene, did not enter into an alkylation and the products obtained were recognized as those from the alkenes themselves. The formation of appreciable quantities of 2,2,4-trimethylpentane in the reaction of isobutane with propene was ascribed to dehydrogenation of the isobutane into isobutene, which then reacts with the excess of isobutane present.

Formations of various by-product isoalkenes from isobutane and "butene" were explained by the following scheme:

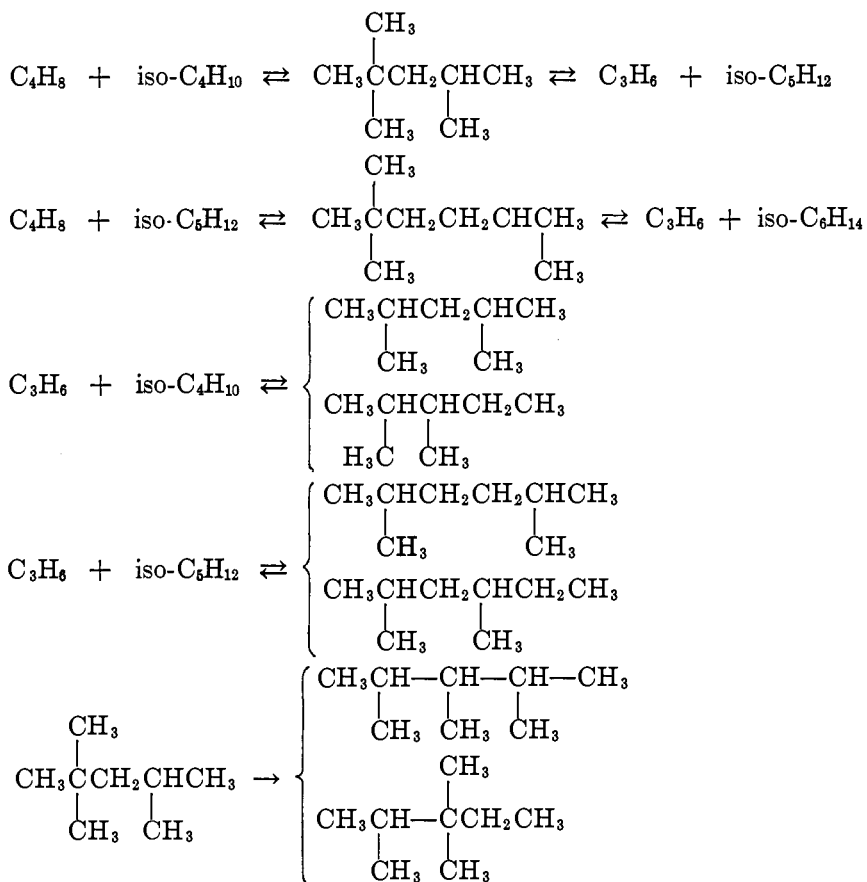

The "butene" can contain considerable amounts of 1,3-butadiene, i.e., 22 per cent, without a noticeable adverse effect. Presumably hydrogenation of the butadiene into 1-butene and 2-butene occurs at the expense of some of the isobutane. At present only a few octanes have been isolated from isobutane-butene alkylate. From the suggested occurrence of isomerization of initial alkene and of isoalkanes from the alkylation proper, it is deducible that the iso-octanes listed as products of the alkylation can be accounted for on a qualitative basis. It would not surprise the present authors, however, if difficulties arise in the foregoing theory as quantitative data become available. For example, there are eighteen isomeric octanes whose presence or absence among alkylates must be accounted for.

Another study of the alkylation of isoalkanes reveals that absorption of alkenes *per se* in sulfuric acid occurs about 700 times faster than that of isoalkanes without alkenes (2). The alkylation was considered to involve absorption and coupling steps:

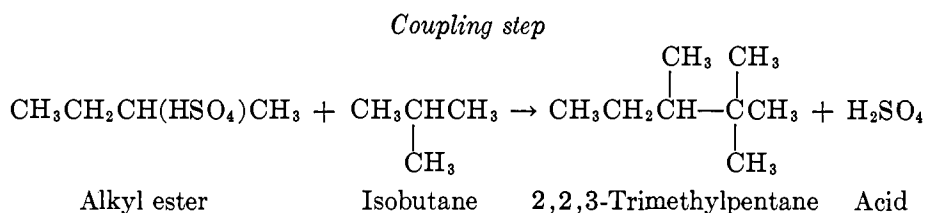
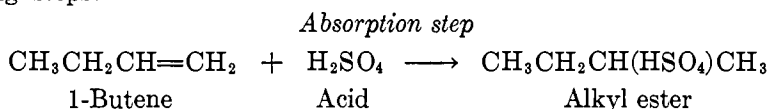

This mechanism assigns a greater initial activity of alkenes than of isoalkanes toward sulfuric acid, contrary to the requirements of the alkylation mechanism proposed by Dunstan and coworkers. The postulated 2,2,3-trimethylpentane remains to be confirmed as an actual product.

In a discussion of the paper of Birch and Dunstan (6), Waters interpreted the sulfuric acid-catalyzed alkylations of isoalkanes by alkenes as reactions of ionic type brought about by the highly polar acid (55):

(a) Whitmore's scheme for activation of alkenes by proton addition:

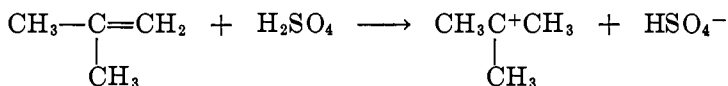

(b) Ionization of the isoalkane by proton release:

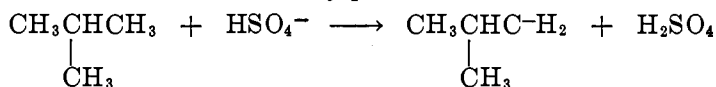

(c) Addition of the two reactive organic ions:

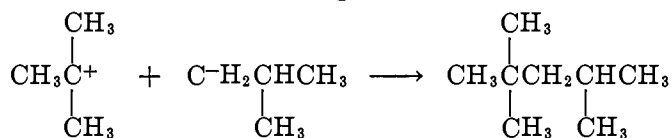

This mechanism is similar to that of Birch and Dunstan; it does not lead to different conclusions. While the formation of complexes with sulfuric acid is not postulated, transfers of a proton from the acid to the alkene and from the alkane to the proton-deficient acid (hydrosulfate ion) are assumed. Addition of carbonium ions and carbanions is the concluding step. The tertiary carbon atom of isobutane was considered to have a more electronegative environment than that possessed by an adjacent methyl group carbon atom on account of the cumulative induced polar effect of the electrical dipoles associated with the methyl groups. A group (hydrogen atom) attached to the tertiary carbon atom was taken to be more easily dissociated as an anion than as a cation (proton). Dissociation of protons from alkanes was therefore anticipated in the order $\text{CH}_3 > \text{CH}_2 > \text{CH}$. It was pointed out that methyl groups are most prevalent among isoalkanes. Because the internal polar forces (i.e., the local dipoles) in all alkanes are very small in magnitude, Waters stated, "... one would not anticipate that the relative reactivities of the various parts of any hydrocarbon molecule would be so markedly different as to necessitate the occurrence of reactions of one type only."

A markedly different type of mechanism is proposed by McAllister, Anderson, Ballard, and Ross, who postulate an addition of alkane fragments to an alkene in alkylation with sulfuric acid (37). The alkane fragments are considered to be formed by scission of C—C bonds only. A number of side reactions, such as isomerization or depolymerization of alkenes, are included, thus accounting for the observed products in a qualitative manner. Secondary alkylations traceable to a dehydrogenation of some of the starting isoalkane are also postulated; these predict a formation of 2,2,4-trimethylpentane whenever isobutane is used as part of the feed material. The following five types of reactions were considered to correspond to the structures of their observed products:

(1) Hydrogenation:

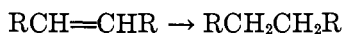

(2) Depolymerization:

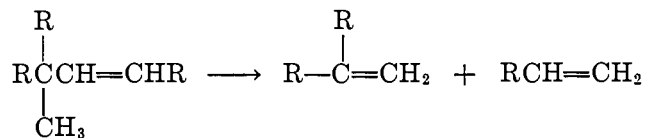

(3) Alkene isomerization:

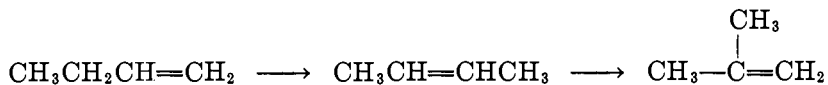

(4) Carbon-to-carbon cleavage:

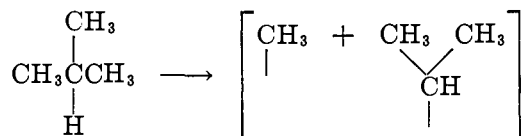

(5) Addition of fragments to alkenes:

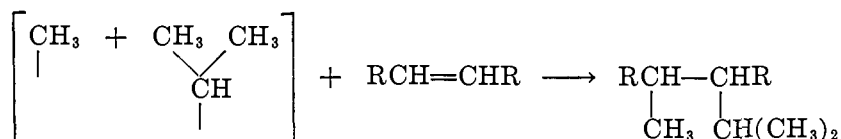

Each of the preceding reactions involves scission of a carbon-carbon bond. Double bonds are replaced by single bonds in reactions 1, 3, and 5, whereas single bonds are broken in reactions 2 and 4. Reactions 2 and 3 require also scission of carbon-hydrogen bonds, which are thermodynamically more stable than either a single carbon-carbon bond or the π bonding of a double bond. Figures 9 and 10 illustrate the proposed mechanism of alkylation of isobutane by propene and butenes.

Table 35 gives the composition of alkylates corresponding to actual tests (table 19) and compares these with the products expected from: (a) direct alkylation, assuming that isobutane dissociates initially into methyl and isopropyl fragments, which then add to the alkene, (b) hydrogenation of the starting alkene, and (c) secondary alkylation, assuming that isobutane dissociates into methyl and isopropyl fragments and into isobutene plus hydrogen, which recombine to form higher isoalkanes (isoöctanes).

The reaction of isobutane with propene gave all hydrocarbons demanded by theory, including 2,3-dimethylbutane (figure 9). Isobutane and 2-butene gave isopentane (trace), 2,3-dimethylbutane, 2,2,4-trimethylpentane, 2,3,3- or 2,3,4-trimethylpentane, and probably some isobutane. No 2,4- or 2,5-dimethylhexane was found in the product, contrary to Birch and Dunstan (6) though in accordance with the present theory (figure 10) (compare tables 34 and 35). The propene trimer fraction did not alkylate isobutane but gave principally isoöctanes and isononanes, presumably by accepting hydrogen from half of the isobutane. In the attempted alkylation of isobutane by diisoomylene some depolymerization-hydrogenation into isopentane occurred. The main reaction was hydrogenation of diisoomylene into isodecanes at the expense of some isobutane. Isoöctanes probably were formed by the combination of excess isobutane with isobutene of dehydrogenation.

Caesar and Francis have proposed an intermolecular methyl-transfer mechanism for the low-temperature alkylation of isoalkanes by alkenes as catalyzed by metal halides or sulfuric acid (12). They state that the alkene wedges itself in between a methyl group and the rest of an isoalkane, the methyl group adding to one side of the double bond and the remainder of the isoalkane adding to the other side. Their general theory, consequently, parallels to a large extent that of McAllister *et al.* In the case of alkylation of isobutane by ethene, the general theory of Caesar and Francis accounts only for the presence of 2-methylpentane. Formation of 2,2-dimethylbutane is not provided for. An unprecedented addition of methyl and isopropyl groups across ethylidene is used to explain the observed formation of 2,3-dimethylbutane. Explanations involving similar alkylidene radicals were not used in the case of other alkylations

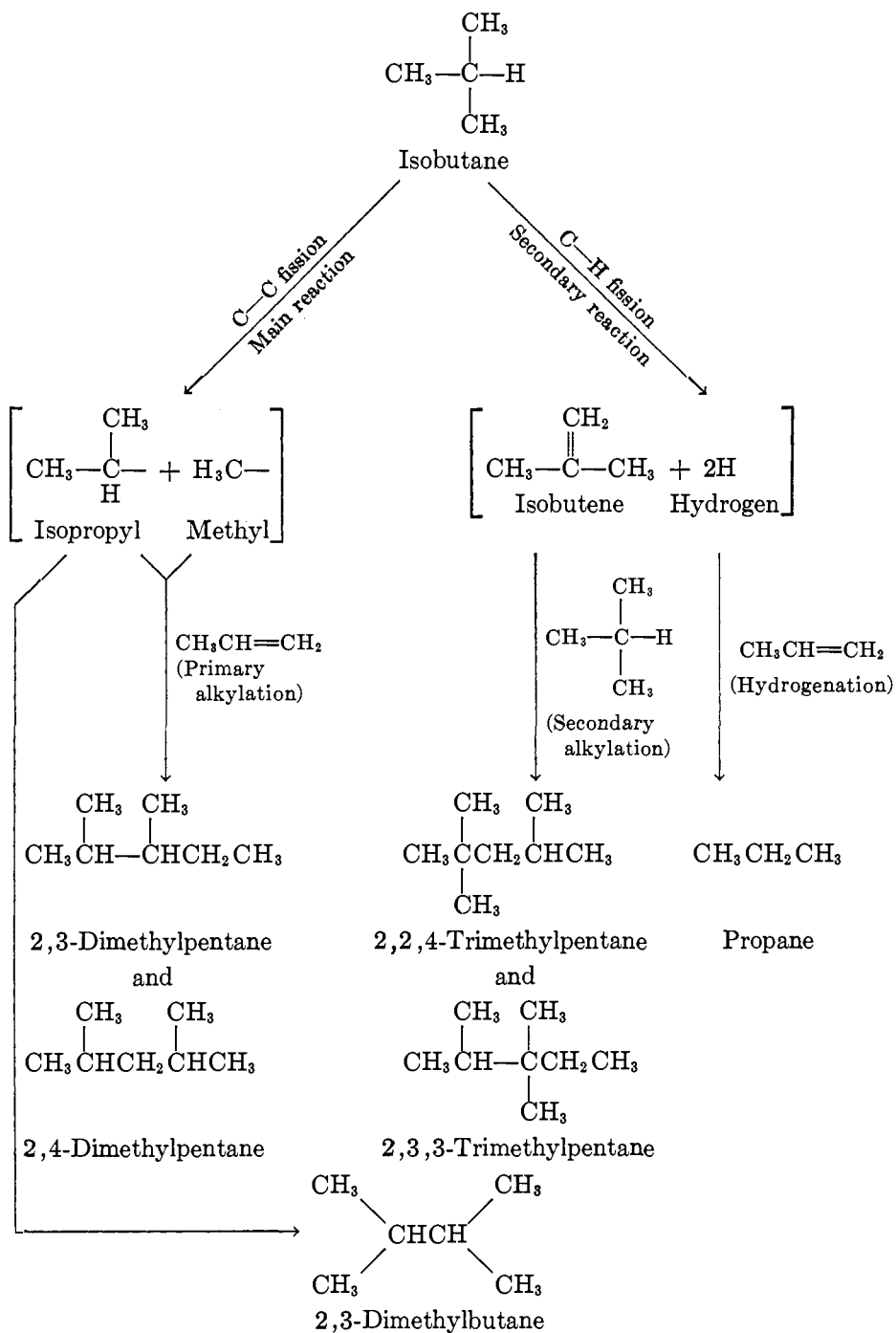

FIG. 9. Alkylation of isobutane with propene (McAllister, Anderson, Ballard, and Ross)

(table 36). Straight-chain butenes and isobutene are considered to give the same final products when they react with isobutane; this phenomenon is ascribed to a facile isomerization of the alkenes. 2,5-Dimethylhexane, formed in appreciable quantities in the sulfuric acid-catalyzed reaction (7, 9) of isobutane with isobutene, is taken as a secondary product from the similarly catalyzed reaction (8) of isopentane with isobutene to give 2,2,5-trimethylhexane.

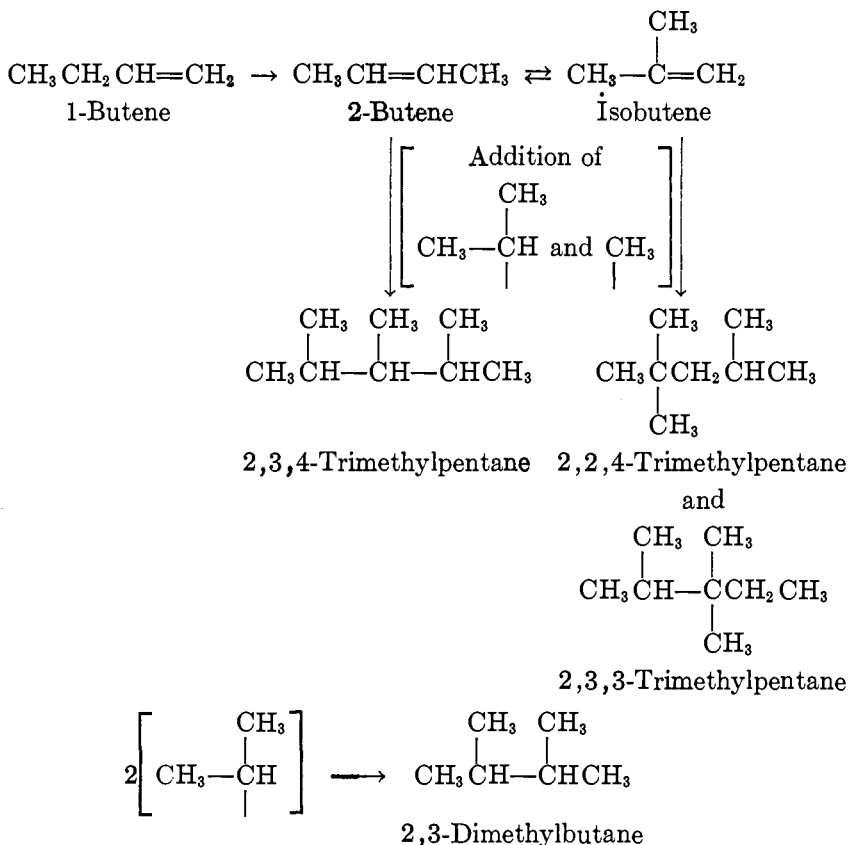

Fig. 10. Alkylation of isobutane with 1-butene, 2-butene, or isobutene (McAllister, Anderson, Ballard, and Ross).

Caesar and Francis point out that a close agreement exists between (a) the relative amounts of alkane isomers computed from thermodynamic equilibria for alkylates *without* unproposed isomers and (b) those actually formed in the low-temperature alkylation of alkanes by alkenes with metal halides or sulfuric acid (table 37).

Table 37 indicates a borderline agreement of calculated and observed data. It is difficult to believe that only two hexanes, two heptanes, or four to six octanes are present in typical alkylates. Hence, the present authors are of the opinion that the slight discrepancies between the calculated and observed data

TABLE 35
Composition of alkylation products
 (McAllister, Anderson, Ballard, and Ross)

REACTANTS	PRODUCTS OBTAINED, WEIGHT PER CENT	PRODUCTS TO BE EXPECTED FROM DIRECT ALKYLATION	PRODUCTS TO BE EXPECTED FROM HYDROGENATION	PRODUCTS TO BE EXPECTED FROM SECONDARY ALKYLATION
Isobutane and propene.....	2,4-Dimethylpentane 8-12 2,3-Dimethylpentane 62-66 2,2,4-Trimethylpentane 5-9 2,3,4- or 2,3,3-Trimethylpentane 6-10 Propane also formed	2,4-Dimethylpentane 2,3-Dimethylpentane	Propane	2,2,4-Trimethylpentane 2,3,3-Trimethylpentane
Isobutane and 2-butene.....	Isopentane Trace 2,3-Dimethylbutane 4-6 2,2,4-Trimethylpentane 34-38 2,3,4- or 2,3,3-Trimethylpentane 51-55 Isobutane probably also formed	2,2,4-Trimethylpentane 2,3,4-Trimethylpentane 2,3,3-Trimethylpentane	<i>n</i> -Butane (not found) Isobutane	2,2,4-Trimethylpentane 2,3,3-Trimethylpentane
Isobutane and 2-pentene.....	Isopentane 6-8 2,2,4-Trimethylpentane 6-10 2,3,4- or 2,3,3-Trimethylpentane 8-12 Isononanes 55-65	Isononanes	<i>n</i> -Pentane (not found) Isopentane	2,2,4-Trimethylpentane 2,3,3-Trimethylpentane
Isobutane and isobutene.....	Isopentane 7-9 2,3-Dimethylbutane 8-10 2,2,4-Trimethylpentane 24-28 2,3,4- or 2,3,3-Trimethylpentane 30-34 Isobutane probably also formed	2,2,4-Trimethylpentane 2,3,3-Trimethylpentane	Isobutane	2,2,4-Trimethylpentane 2,3,3-Trimethylpentane
Isobutane and 2-methyl-2-butene.....	Isopentane 18-20 2,3-Dimethylbutane 5-7 2,2,4-Trimethylpentane 14-16 2,3,4- or 2,3,3-Trimethylpentane 15-17 Isononanes 15-20	Isononanes	Isopentane	2,2,4-Trimethylpentane 2,3,3-Trimethylpentane

Isobutane and octenes from 2-ethyl-1-hexanol.....	Isopentane	3- 5	Isododecanes	3-Methylheptane	2,2,4-Trimethylpentane 2,3,3-Trimethylpentane
	2,3-Dimethylbutane	3- 5			
	2,2,4-Trimethylpentane	12-16			
	2,3,3-Trimethylpentane	(?)			
	3-Methylheptane	35			
	Isododecanes	(?)			
Isobutane and propene trimers.....	Isopentane	2- 3	Isotridecanes (not found)	Hydrogenated trimers	2,2,4-Trimethylpentane 2,3,3-Trimethylpentane
	2,3-Dimethylbutane	1- 2			
	2,2,4-Trimethylpentane	15-20			
	2,3,4- or 2,3,3-Trimethylpentane	18-20			
	Hydrogenated trimers	45			
Isobutane and butene dimers	Isopentane	6- 7	Isododecanes	Hydrogenated dimers	2,2,4-Trimethylpentane 2,3,3-Trimethylpentane
	2,3-Dimethylbutane	5- 6			
	2,2,4-Trimethylpentane	} 60-65			
	2,3,3- or 2,3,4-Trimethylpentane				
	Hydrogenated dimers (?)				
Isododecanes (?)	(?)				
Isobutane and butene trimers	Isopentane	5- 6	Isohexadecanes (not found)	Hydrogenated trimers	2,2,4-Trimethylpentane 2,3,3-Trimethylpentane
	2,3-Dimethylbutane	3- 5			
	2,2,4-Trimethylpentane	} 60-65			
	2,3,4- or 2,3,3-Trimethylpentane				
	Hydrogenated trimers				
Isobutane and diisoamylene	Isopentane	10-12	Isotetradecanes (not found) Isononanes (not found)	Isodecanes Isopentane*	2,2,4-Trimethylpentane 2,3,3-Trimethylpentane
	2,3-Dimethylbutane	2- 3			
	2,2,4-Trimethylpentane	20-25			
	2,3,4- or 2,3,3-Trimethylpentane	20-25			
	Isodecanes	16-20			

* From depolymerization and subsequent alkylation.

are indicative *inter alia* of the presence of small amounts of such alkanes as 3-methylpentane, 2,2-dimethylbutane, 2,3-dimethylhexane, and 2,2,3-trimethylpentane, variously reported in the present review. In the case of alkylations by 1-butene, 2-butene, or isobutene, theoretical considerations on reaction velocities indicate that the composition of alkylates should be markedly dependent on the particular butene used.

TABLE 36
Products from the alkylation of isobutane and isopentane
(Caesar and Francis)

REACTANTS	PRODUCTS*	
1. Isobutane and ethene	$\begin{array}{c} \text{C} \\ \\ \text{C}-\text{C}-\text{c}-\text{c}-\text{C} \end{array}$	$\begin{array}{c} \text{C} \quad \text{C} \\ \quad \\ \text{C}-\text{C}-\text{c}-\text{c} \end{array}$
2. Isobutane and propene	$\begin{array}{c} \text{C} \quad \text{c} \\ \quad \\ \text{C}-\text{C}-\text{c}-\text{c}-\text{C} \end{array}$	$\begin{array}{c} \text{C} \quad \text{c} \\ \quad \\ \text{C}-\text{C}-\text{c}-\text{c}-\text{C} \end{array}$
3. Isobutane and 1-butene	$\begin{array}{c} \text{C} \quad \text{C} \\ \quad \\ \text{C}-\text{C}-\text{c}-\text{c}-\text{c}-\text{c} \end{array}$	$\begin{array}{c} \text{C} \quad \text{c}-\text{C} \\ \quad \\ \text{C}-\text{C}-\text{c}-\text{c}-\text{c} \end{array}$ (not positively identified)
4. Isobutane and 2-butene	$\begin{array}{c} \text{C} \quad \text{c} \quad \text{c} \\ \quad \quad \\ \text{C}-\text{C}-\text{c}-\text{c}-\text{C} \end{array}$	
5. Isobutane and isobutene	$\begin{array}{c} \text{C} \quad \text{c} \\ \quad \\ \text{C}-\text{C}-\text{c}-\text{c}-\text{C} \\ \\ \text{c} \end{array}$	$\begin{array}{c} \text{C} \quad \text{c} \\ \quad \\ \text{C}-\text{C}-\text{c}-\text{c}-\text{C} \\ \\ \text{c} \end{array}$
6. Isopentane and propene	$\begin{array}{c} \text{C} \quad \quad \quad \text{c} \\ \quad \quad \quad \\ \text{C}-\text{C}-\text{C}-\text{c}-\text{c}-\text{C} \end{array}$	$\begin{array}{c} \text{C} \quad \quad \quad \text{c} \\ \quad \quad \quad \\ \text{C}-\text{C}-\text{C}-\text{c}-\text{c}-\text{C} \end{array}$
7. Isopentane and isobutene	$\begin{array}{c} \text{C} \quad \quad \quad \text{c} \\ \quad \quad \quad \\ \text{C}-\text{C}-\text{C}-\text{c}-\text{c}-\text{C} \\ \\ \text{c} \end{array}$	(other nonanes not identified)

* Carbon atoms from the isoalkane are in capital letters.

A different type of mechanism has been proposed by Schmerling (49). He suggests that alkylation of alkanes by alkenes in the presence of aluminum chloride and hydrogen chloride is a chain reaction involving transient conversion of the alkanes into alkyl chlorides. Schmerling has shown that an alkyl chloride can add to an alkene, forming a higher alkyl chloride in the absence of an alkane. Such higher alkyl chlorides are considered to exchange their chlorine for a hydro-

gen atom of the initial alkane, producing the alkylated alkanes. *Alkyl halide from the last reaction is considered to continue the process in the cyclical manner.* A preliminary formation of alkyl halide from a small portion of the alkene probably starts off the process. The reaction of isobutane with ethene to form 2,3-

TABLE 37
Thermodynamic equilibria of isomeric alkanes at 25°C.
 (Caesar and Francis)

	$\Delta F (n = 0)$	PER CENT	PER CENT IN ALKYLATE	
			Calculated	Found
<i>n</i> -Butane.....	0	32	32	20
Isobutane.....	-442	68	68	80
<i>n</i> -Pentane.....	0	4	13	10
Isopentane.....	-1097	25	87	90
Neopentane.....	-1720	71	0	0
<i>n</i> -Hexane.....	0	4	0	0
2-Methylpentane.....	-558	11	26	10-25
3-Methylpentane.....	-558	11	0	0
2,2-Dimethylbutane.....	-1341	42	0	0
2,3-Dimethylbutane.....	-1165	32	74	75-90
<i>n</i> -Heptane.....	0	0.7	0	0
One branch.....	-1035	4	0	0
2,2- and 3,3-dimethylpentanes.....	-1817	14.5	0	0
2,3-Dimethylpentane.....	-1543	9	50	50 ±5
2,4-Dimethylpentane.....	-1543	9	50	50 ±5
Triptane (2,2,3-trimethylbutane).....	-2426	40	0	0
<i>n</i> -Octane.....	0	0.3	0	0
One branch.....	-577	0.8	0	0
Gem groups.....	-1361	2.9	0	0
2,3- and 3,4-dimethylhexanes.....	-1185	2.1	0	0
3-Ethyl-2-methylpentane.....	-1185	2.1	4.7	0-10
2,4-Dimethylhexane.....	-1185	2.1	4.7	} 10-15
2,5-Dimethylhexane.....	-1185	2.1	4.7	
Isooctane (2,2,4-trimethylpentane).....	-2654	25	56	50-60
2,2,3-Trimethylpentane.....	-1968	8	0	0
2,3,3-Trimethylpentane.....	-1968	8	17	} 25-30
2,3,4-Trimethylpentane.....	-1793	6	13	
Hexamethylethane.....	-2752	30	0	0

dimethylbutane is considered to involve three main steps. First, an initiating step produces a limited, reaction-iciting quantity of *tert*-butyl chloride, probably through a chlorine-hydrogen exchange involving ethyl chloride, as follows:

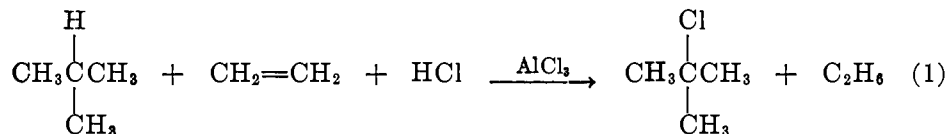

Succeeding steps are taken to be those of a chain reaction utilizing and regenerating *tert*-butyl chloride:

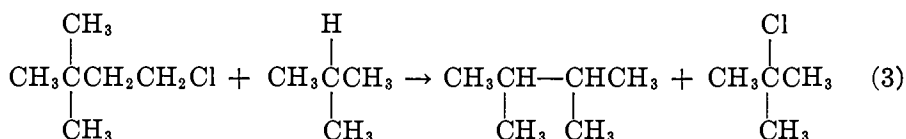
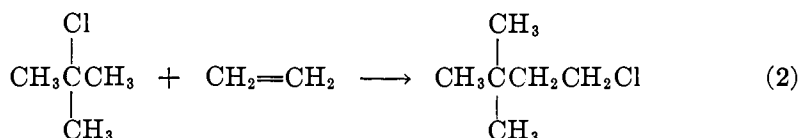

Similar reactions are assumed to occur with other isoalkanes and alkenes. Skeletal isomerization involving the neohexyl group was compared to that characteristic of the neopentyl group, which is a major part of the neohexyl group.

Bartlett, Condon, and Schneider (4) have demonstrated chlorine-hydrogen exchanges. They have investigated and observed the following exchange reactions of isoalkanes:

- (1) Isopentane + isopropyl chloride + $\text{AlBr}_3 \rightarrow$ *tert*-amyl bromide.
- (2) Isopentane + *tert*-butyl chloride + AlBr_3 (contact time 0.001 sec.) \rightarrow *tert*-butyl bromide (slight amount) + *tert*-amyl bromide + *tert*-amyl chloride (slight amount).
- (3) Isopentane + *tert*-butyl chloride + AlBr_3 (contact time 1 sec.) \rightarrow either 2-methylpentane or 2,3-dimethylbutane + high-boiling alkylate + *tert*-amyl bromide + 3-bromo-2-methylbutane.
- (4) Isopentane + *tert*-amyl bromide + $\text{AlBr}_3 \rightarrow$ either 2-methylpentane or 2,3-dimethylbutane + 3-bromo-2-methylbutane.
- (5) Isopentane + 4-chloro-2,2,4-trimethylpentane (diisobutylene hydrochloride) + $\text{AlCl}_3 \rightarrow$ 2,2,4-trimethylpentane + *tert*-amyl chloride + nonyl chlorides.
- (6) 3-Methylpentane + *tert*-amyl bromide + aluminum halide \rightarrow isopentane + bromohexanes.
- (7) 2,3-Dimethylbutane + *tert*-butyl chloride + $\text{AlCl}_3 \rightarrow$ 2-chloro-2,3-dimethylbutane.
- (8) 2,2,3-Trimethylbutane + *tert*-butyl chloride + $\text{AlCl}_3 \rightarrow$ 3-chloro-2,2,3-trimethylbutane.
- (9) 2,2,4-Trimethylpentane + *tert*-butyl chloride + $\text{AlCl}_3 \rightarrow$ products distilling 31–103°C. (no chlorotrimethylpentane).

In the case of the isopentane, *tert*-butyl chloride, and aluminum bromide mixture, the fastest reaction was probably a chloride-bromide exchange affecting the *tert*-butyl chloride. The slight amount of *tert*-butyl bromide so formed disappeared within 1 sec. Within the same time interval, a considerable portion of the *tert*-amyl bromide initially formed from the isopentane was isomerized to 3-bromo-2-methylbutane. Also, there developed the first indication of low- and high-boiling "alkylation" products. Thus the first distinctly recognizable

reaction between isopentane and *tert*-butyl chloride with aluminum bromide is "an extremely rapid *halogen-hydrogen exchange* in which the original paraffin is converted into halide and the original halide into paraffin:

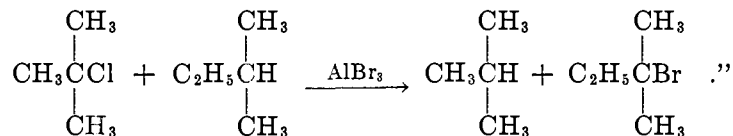

The resulting *tert*-amyl bromide was isolated in 50–70 per cent yields. No halogen-hydrogen exchange occurred when *n*-pentane was substituted for isopentane. A chlorotrimethylpentane was absent from the products of an interaction between 2,2,4-trimethylpentane, *tert*-butyl chloride, and aluminum chloride, although a related reverse reaction occurred normally (see exchange reaction 5, in which isopentane was used instead of isobutane because of more convenient boiling point).

Bartlett and coworkers (4) have discussed Schmerling's mechanism of alkane alkylation in terms of carbonium ions or "active fragments with an electron-deficient carbon atom," leaving open the question of whether the lifetime of the intermediate is such as to justify the use of the term "ion." Bartlett accounts for "normal" products of alkylation by the following sequence of reactions in accordance with Schmerling's mechanism, using the alkylation of isobutane by *tert*-butyl chloride and aluminum chloride as an example:

(1) Reversible elimination of hydrogen halide:

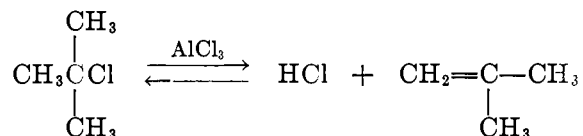

(2) Addition of halide to alkene:

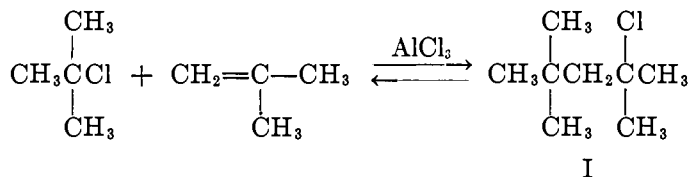

(3) Halogen-hydrogen exchange:

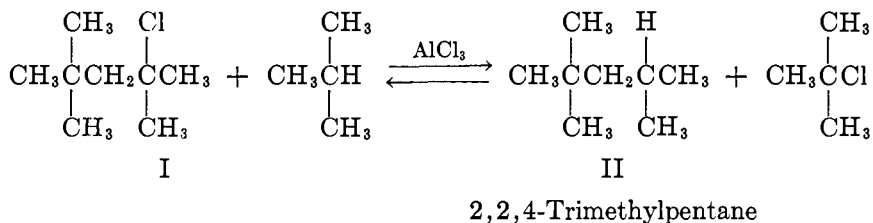

(4) Partial isomerization (analogous to that observed with *tert*-amyl bromide and aluminum bromide):

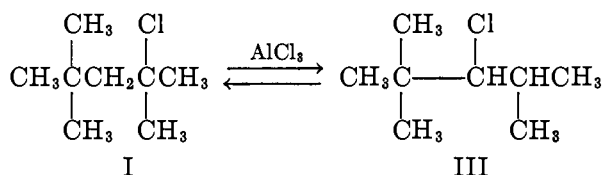

(5) Wagner-Meerwein rearrangement:

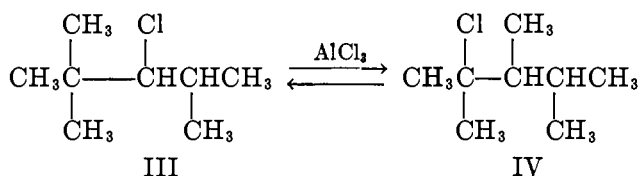

Product IV upon halogen-hydrogen exchange would give some 2,3,4-trimethylpentane, which will be designated as V. The latter was stated to be "subject to further halogen-hydrogen exchanges and isomerization from which 2,3,3- and 2,2,3-trimethylpentanes can be derived strictly in accordance with demonstrated analogy."

Detailed mechanisms in terms of "carbonium ions" were then presented for the sequence of reactions leading to "normal" products. Reaction 1 (reversible elimination of hydrogen halide) was taken as a very rapid equilibrium because of the highly ionic complexes formed between aluminum halides and organic halides:

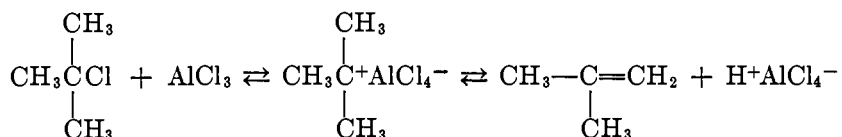

Reaction 2 (addition of halide to alkene) was postulated to proceed by way of the ionic complex,

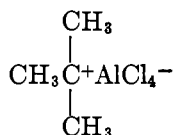

in the manner of an ionic mechanism of polymerization. Reaction 3 (halogen-hydrogen exchange), which is competitive with isomerization, rearrangement, and "depolymerization" (cracking) in the presence of aluminum halides, was considered to be a process in which an actual or virtual alkyl ion (from an ionic complex such as I + AlCl₃) collides with an alkane. The latter supplies the alkyl ion with a hydrogen particle and a pair of bonding electrons. The cor-

responding reaction between isopentane and *tert*-butyl chloride was illustrated by the following equations:

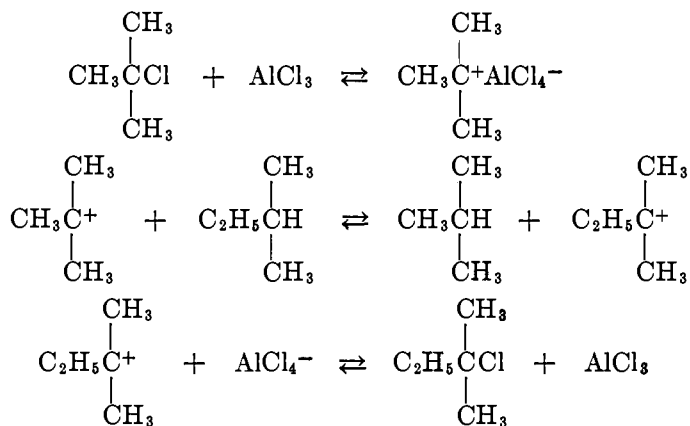

Reaction 4 (partial isomerization of alkyl halide) was formulated as an elimination and readdition of hydrogen halide or of chlorine ions, although "it is not at all certain that a proton needs to leave the carbonium ion in order to bring about the isomerization." Thus a reversible isomerization of carbonium ions

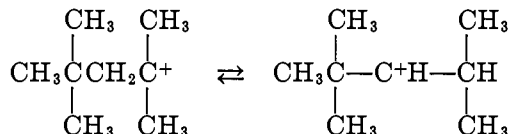

would permit a direct shift of a hydrogen with its electron pair from one carbon to the next. Reaction 5 was pointed out as a practically irreversible isomerization of a "pinacolyl" type halide (III), leading to the formation of 2,3,4-trimethylpentane (V) and isomers therefrom in competition with formation of 2,2,4-trimethylpentane (II of reaction 3).

"Abnormal" products encountered in alkylation were accounted for on several bases. One (mentioned only because it had not been definitely disproved) was the direct transfer of an alkyl group, presumably with its pair of bonding electrons, from one hydrocarbon to another. A second explanation was cleavage of a larger molecule into fragments. In particular, ionic cleavage of carbonium ions from I and IV (precursors of 2,2,4- and 2,3,4-trimethylpentanes) would give normal and abnormal fragments, respectively:

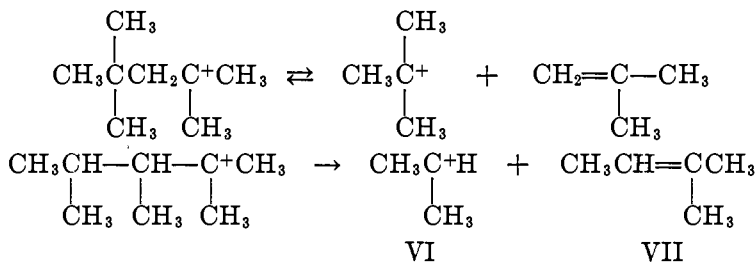

The isopropyl positive fragment (VI) would immediately attach itself to an isobutene molecule, forming 2,4-dimethyl-1-pentene, which would yield the corresponding alkane upon addition of hydrogen chloride followed by chlorine-hydrogen exchange. In a similar manner, 2-methyl-2-butene (VII) could produce polymers, copolymers, or isopentane.

The reaction of isopentane with isobutene and aluminum bromide was presented as evidence that formation of an alkene polymer is an intermediate step in the formation of "abnormal" products in low-temperature alkylation. Reactants precooled to 0°C. gave polyisobutene (contact time 0.2 sec.), but a typical alkylate appeared at room temperature with a contact time of 105 min. This gives support to the idea that the alkylate consists largely of cleavage products of polyisobutene. A similar mechanism could not be given for alkylations of isobutane by ethene or propene in which "abnormal" products are notably less abundant. Formation of highly unsaturated hydrocarbons (reaction residues) in alkylations using aluminum halide were explained by the scheme:

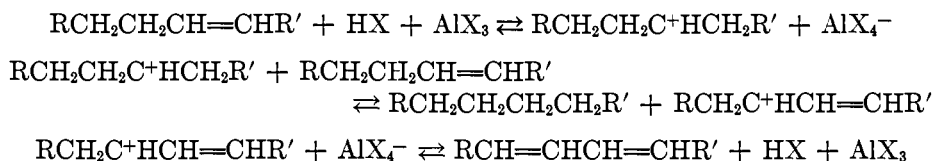

Resonance would stabilize the conjugated hydrocarbons produced according to the last equation.

In a longer paper following his preliminary communication (49) to the Journal of the American Chemical Society, Schmerling has recently discussed his chain mechanism for alkane alkylation in more detail. The alkylation of isoalkanes by alkenes is considered to involve the following key reactions (50) analogous to those previously outlined: (1) conversion of the isoalkane to a *tert*-alkyl ester; (2) addition of the *tert*-alkyl ester to the alkene to yield an ester of higher molecular weight; (3) reaction of the ester of higher molecular weight with the isoalkane to yield the observed alkane product and a new molecule of the *tert*-alkyl ester.

The *tert*-alkyl ester formed in the third step reacts with alkene as in the second step and the cycle is repeated. The possible separate occurrence of each step in the mechanism has been proved only in the case of the aluminum chloride reaction. Since the alkylation products obtained with other catalysts, including sulfuric acid and hydrogen fluoride, are similar to those obtained with aluminum chloride, Schmerling presumes that analogous reactions occur with these other catalysts, the reaction intermediates being the *tert*-alkyl hydrogen sulfates and *tert*-alkyl fluorides, respectively, rather than the *tert*-alkyl chlorides. He states: ". . . it seems desirable to emphasize the key steps of the reaction chain, to give experimental 'molecular' proof of their feasibility, and to abstain in so far as possible from expressing the mechanism in terms of ions or other inner underlying motivators. It is quite probable that catalytic alkylation is motivated by the same forces that cause other catalytic reactions."

Hydrogen-chlorine exchange reactions (reactions 1 and 3) and the addition of *tert*-butyl chloride to an alkene (reaction 2), for example, are presumed to proceed by either a molecular or an ionic mechanism, either with or without the intermediate formation of an aluminum chloride complex, such as alkyl aluminum tetrachloride, RAlCl_4 . The function of hydrogen chloride as promoter for aluminum chloride in the alkylation of isoalkanes is presumed to be the initiation and maintenance of the formation of a *tert*-alkyl halide according to reaction 1. Also, it might convert the metal halide to the more active acidic form, HAlCl_4 . It is pointed out that present-day theory favors the ionic scheme; rearrangement which occurs during the last exchange reaction (reaction 3) was taken as especially well explained by Whitmore's "common basis of intramolecular rearrangements" or the so-called "carbonium ion" theory.

An insight into the causes for the relative difficulty with which normal alkanes are alkylated was given. The first exchange reaction (reaction 1) does not take place as easily with hydrogen atoms attached to secondary carbon atoms (see page 385) as it does with those attached to tertiary carbon atoms. Under the conditions required to obtain the hydrogen-halogen exchange reaction with normal alkanes, polymerization of the alkene becomes the predominant reaction.

Additional evidence was presented for the three key steps:

For equation 1:

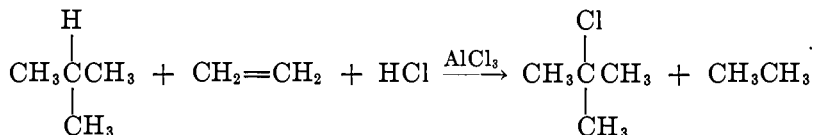

Ethene and hydrogen chloride probably form ethyl chloride. The latter is reduced to ethane by reaction with *n*-heptane in the presence of aluminum chloride (40). At the same time, the heptane is converted largely into cyclanes and into unsaturated hydrocarbons combined with the catalyst in the so-called "lower layer." Ethane and propane have been obtained as by-products of the aluminum chloride-catalyzed alkylation of isobutane with ethene and propene, respectively (53). Propane has been isolated from the products of an alkylation of isobutane by propene in the presence of sulfuric acid (37). The reaction of isobutane with isopropyl chloride gives propane, octanes, and catalyst complex (53). When a solution of aluminum bromide in isopentane is brought into contact with isopropyl chloride or *tert*-butyl chloride at room temperature, one of the principal products is *tert*-amyl bromide (4).

For equation 2:

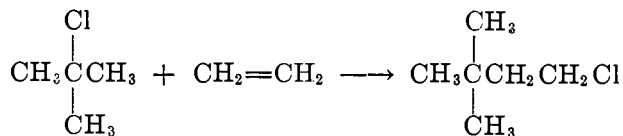

"An investigation [48a] of the condensation of alkyl halides with olefins in the presence of metal halide catalysts has shown that the primary reaction is that of addition of the alkyl group and the halogen atom to the double bond of the olefin. For example, a 75% yield of 1-chloro-3,3-dimethylbutane is obtained by the addition of *t*-butyl chloride to ethylene in the presence of aluminum chloride at -15° to -10° [48a]. The reaction of *t*-butyl chloride with other olefins occurs in an analogous manner. The primary product of the reaction with propene, for example, is 2-chloro-4,4-dimethylpentane; under some conditions this is isomerized in part to 2- and 3-chloro-2,3-dimethylpentane."

For equation 3:

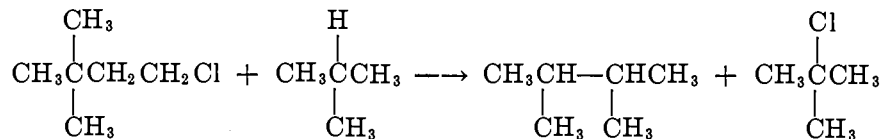

"The reaction involved in this step is essentially the same as that in Eq. 1, the chief difference being that in this case the isobutane reacts with an alkyl chloride of higher molecular weight. Excellent evidence that such chlorides are reduced to paraffins in the presence of isobutane may be found in the results obtained by the condensation of isobutane with allyl chloride in the presence of aluminum chloride [48]. At low temperatures (below 0°) the chief product is 1-chloro-3,4-dimethylpentane. At higher temperatures interaction of this chloroheptane with excess isobutane results in the formation of heptane and other paraffinic hydrocarbons, the latter being produced by secondary reactions of the intermediate *t*-butyl chloride.

"Direct proof that rearrangement of the carbon skeleton of the alkyl chloride occurs during its conversion to paraffin was obtained by showing that 2,3-dimethylbutane and *t*-butyl chloride are major products of the reaction of 1-chloro-3,3-dimethylbutane with isobutane in the presence of aluminum chloride at 22° ; relatively little 2,2-dimethylbutane is formed. The rearrangement is not unexpected since a neopentyl system is involved [56]. In some cases, as for example, in the formation of 2,3-dimethylbutane from ethylene or of 2,3-dimethylpentane from propene, the migration of the methyl group is preceded by the migration of one of the methylene hydrogens of the neopentyl group. In other cases, as for example in the formation of 2-methylpentane from ethylene or of 2,4-dimethylpentane from propene, the methyl group undergoes an α,γ -shift.

"Inferential evidence that the hydrogen-chlorine exchange step occurs during alkylation may be obtained from the fact that dichloroalkanes are produced by the low-temperature condensation of isobutane with vinyl chloride and allyl chloride in the presence of aluminum chloride [48]. These dichlorides are formed by the addition of *t*-butyl chloride to the chloro-olefins in a manner similar to the reaction of Eq. 2. In the case of vinyl chloride, the resulting 1,1-dichloro-3,3-dimethylbutane undergoes the reaction analogous to Eq. 3 in only a very small amount; in other words, the condensation is largely "frozen" at the end of the second step, and the dichlorohexane is the chief product. In the case of allyl chloride, on the other hand, the 1,2-dichloro-4,4-dimethylpentane contains a secondary chlorine atom and the major portion reacts with isobutane to yield 1-chloro-3,4-dimethylpentane (the chief product) and *t*-butyl chloride. The isolation of the dichloroalkanes may be used as an argument in favor of employing a 'molecular' rather than an ionic reaction scheme."

Ciapetta, also, has applied carbonium-ion theory to the alkylation of isoalkanes by alkenes in the presence of a catalyst such as concentrated sulfuric acid (13). The isoalkane is considered to form a carbonium ion through "ionization

and partial dehydrogenation," i.e., through loss of a proton followed by elimination of a pair of electrons. Reaction of this carbonium ion with the alkene is then assumed to give a higher carbonium ion, which would produce the corresponding alkane on hydrogenation. The proposed mechanism was illustrated by the alkylation of isobutane with 2-butene (an asterisk indicates the carbon atoms deficient in electrons):

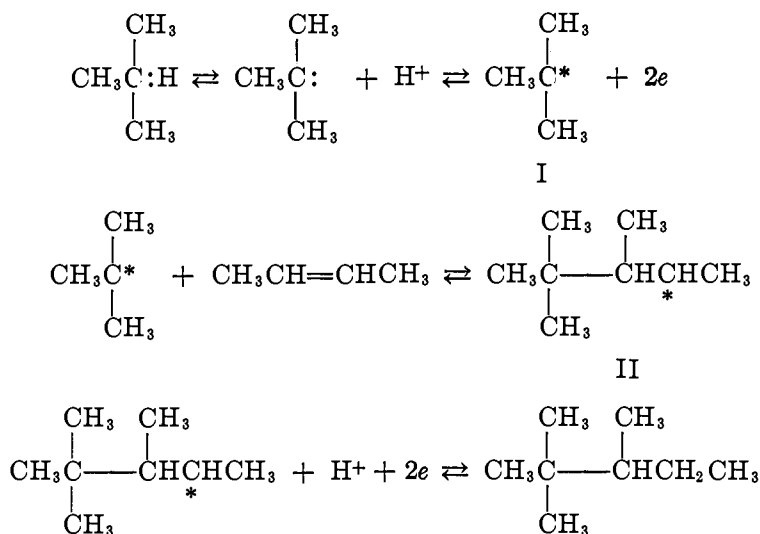

Formation of positive *tert*-butyl ions from isobutane in two steps *via* a negative *tert*-butyl ion is regarded by the present authors as improbable. In particular, the liberation of free electrons by a carbanion can scarcely be correct. The proposed mechanism thus requires revision and cannot be accepted in its present state. In this respect, the chain mechanism proposed by Schmerling has the advantage that it gives a plausible explanation for the continued formation of a *tert*-butyl ion or ester; the second step of Ciapetta's mechanism corresponds to the second or alkylation step discussed by Schmerling and accepted by Bartlett, Condon, and Schneider.

Carbonium ion II was taken as the source of primary and secondary products observed experimentally. Thus, rearrangement of II caused by the shift of a methyl group, alone or with a hydrogen atom together with their bonding electron pairs, explains many of the primary products. "Depolymerization" of II would lead to many of the observed secondary products. The assigned mechanism is in agreement with (a) the molecular hydrogenation-dehydrogenation properties of sulfuric acid and (b) the similarity of carbon skeletons of hydrocarbons produced in the reaction of *n*-butenes with isobutane (alkylation) or with isobutene (copolymerization in less concentrated acid).

The alkylations of isobutane with ethene, propene, isobutene, 1-butene, and 2-butene were depicted as follows (14):

1. Reaction with ethene:

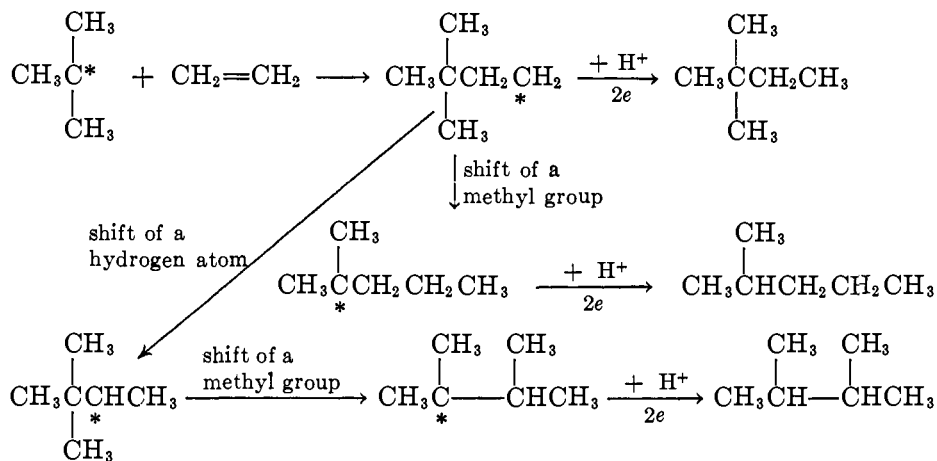

2. Reaction with propene:

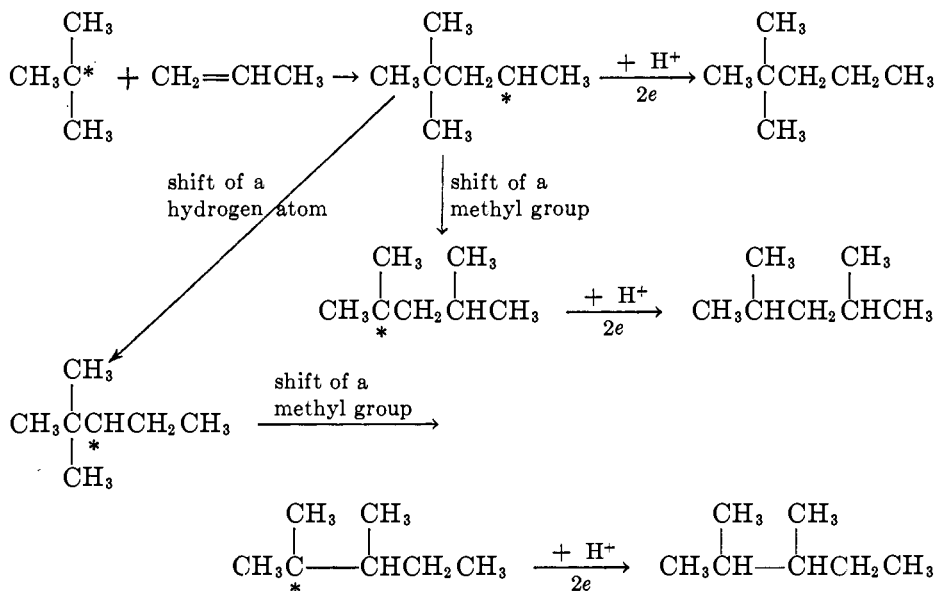

3. Reaction with isobutene:

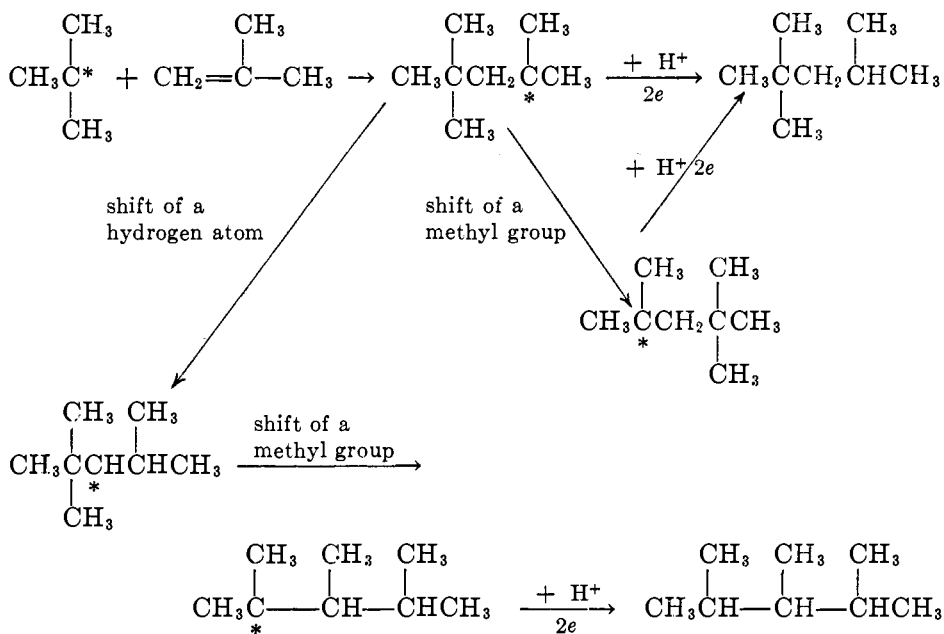

4. Reaction with 1-butene:

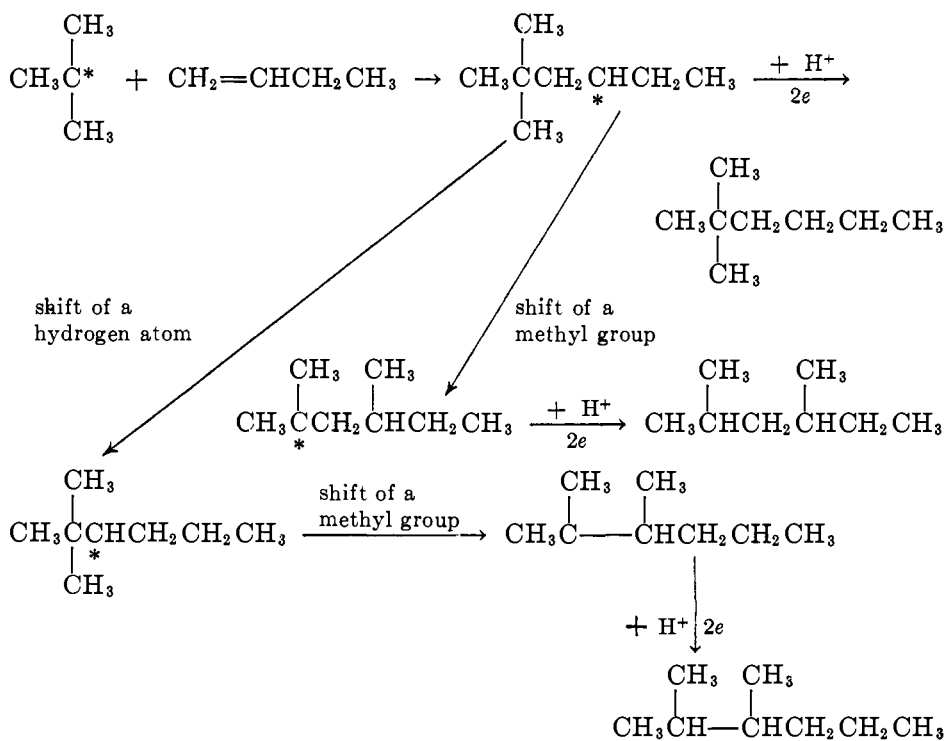

5. Reaction with 2-butene:

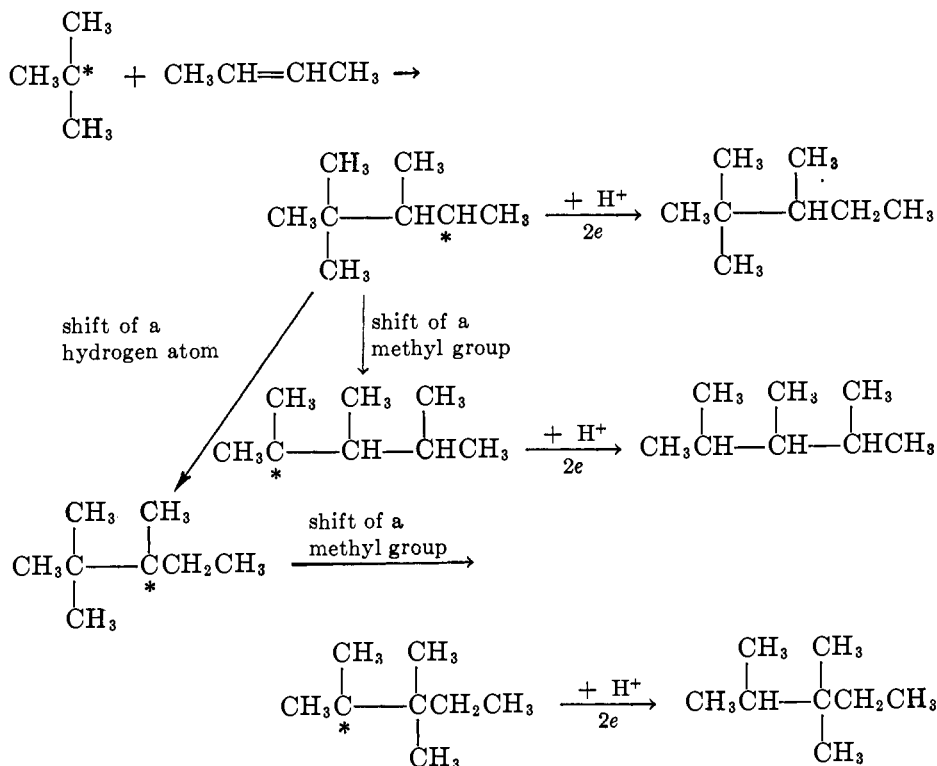

The predicted and experimentally observed products in the alkylation of isobutane by ethene, propene, and "butenes" are compared in table 38.

Table 38 indicates a close parallelism between predicted and observed products. Unfortunately, no details were given about the catalysts used with the enumerated reactants. The predicted primary products for 1-butene, 2-butene, and isobutene were grouped together, "since the experimental data show that the hydrocarbons obtained using either normal butenes or isobutenes are very similar." This behavior is presumably caused by isomerization of the "butenes" prior to reaction with isobutane (37), although "depolymerization" of carbonium ions was taken to be "probably one of the chief causes for the complexity of the products found in all alkylation reactions."

Ciapetta supported his assigned mechanism of alkylation by a literature survey of several reactions of alkanes, alkenes, and alkanols in the presence of sulfuric acid: alkylation of isobutane; hydrogen exchange of alkanes in deuterio-sulfuric acid; degradation of alkanes (reversal of alkylation); polymerization of alkenes; depolymerization of alkenes; conjunct polymerization of alkenes; hydrogen exchange of alkenes in deuteriosulfuric acid; isomerization of alkenes; and dehydration of alkanols. The physical, protolytic, and hydrogenation-

dehydrogenation properties of sulfuric acid were considered also. Its marked hydrogenation-dehydrogenation properties were ascribed to a high dielectric constant, which would also enable it to ionize alkanes. This ionizing ability of sulfuric acid is in agreement with the large autoprotolysis constant,

$$K = [\text{H}_3\text{SO}_4^+][\text{HSO}_4^-]$$

for the reaction



It was pointed out that alkanes without a tertiary hydrogen atom cannot ionize to any great extent in sulfuric acid. The reaction conditions for satisfactory alkylation of alkanes by alkenes were listed as follows (14):

TABLE 38

Comparison of the primary compounds predicted by the carbonium-ion mechanism with those found experimentally in the alkylation of isobutane

(Ciapetta (14))

REACTANTS	PREDICTED PRODUCTS	FOUND EXPERIMENTALLY
Isobutane + ethene.....	2,2-Dimethylbutane 2,3-Dimethylbutane 2-Methylpentane	2,2-Dimethylbutane 2,3-Dimethylbutane 2-Methylpentane
Isobutane + propene	2,2-Dimethylpentane 2,3-Dimethylpentane 2,4-Dimethylpentane	2,2-Dimethylpentane 2,3-Dimethylpentane 2,4-Dimethylpentane
Isobutane + "butenes".....	2,2,4-Trimethylpentane 2,3,4-Trimethylpentane 2,2,3-Trimethylpentane 2,3,3-Trimethylpentane 2,2-Dimethylhexane 2,4-Dimethylhexane 2,3-Dimethylhexane	2,2,4-Trimethylpentane 2,3,4-Trimethylpentane 2,2,3-Trimethylpentane 2,3,3-Trimethylpentane (Not reported) 2,4-Dimethylhexane 2,3-Dimethylhexane 2,5-Dimethylhexane

"1. Only those paraffins which possess a tertiary hydrogen atom will take part in the reaction. To date no one has observed that normal paraffins react with olefins in the presence of concentrated sulfuric acid. This explains why McAllister [37] was unable to react neopentane or neohexane with olefins, which according to his mechanism should give carbon to carbon fission as does isobutane, isopentane and isohexane. Without a tertiary hydrogen atom ionization cannot take place in sulfuric acid to any great extent.

"2. The success of the alkylation reaction will depend on the ratio of isoparaffin to olefin. In the initial step of the proposed mechanism, the formation of a carbonium-ion by the isoparaffin, the forward reactions will be influenced in two ways by the addition of olefin to the isoparaffin in concentrated sulfuric acid. If the olefin is added in small quantities it immediately reacts with the carbonium-ion formed from the isoparaffin and shifts the equilibrium to the right in both steps with the result that the isoparaffin will play a substantial rôle in the reaction. However, if the olefin is added in large amounts so that its concentration far exceeds that of the carbonium-ion formed from the isoparaffin, it can also form

a positive ion as postulated by Whitmore. Increasing the concentration of the positive ion will shift the equilibrium to the left and result in a poor conversion of the isoparaffin.

"3. The concentration of the acid must be higher than 87% in order to get complete saturation of the products since acids of lower strengths as found by Ipatieff [31] give olefins in the product. The hydrogenation-dehydrogenation properties of sulfuric acid depend on its concentration.

"4. A large volume of sulfuric acid must be used for the best results. Ipatieff [31] found in conjunct polymerization of olefins that decreasing the ratio of sulfuric acid to hydrocarbon below 1 to 1 by weight results not only in the formation of large amounts of olefins in the fraction boiling below 225°C., but also decreases the yield of hydrocarbons boiling in this range.

"5. Since the isoparaffin is only slightly soluble in the acid, the probability that the olefin will react with the positive fragment from the isoparaffin will be directly proportional to the efficiency of the agitation. Unless the olefin can come in the vicinity of the carbonium ion formed from the isoparaffin, it will form its own ion and combine with more olefin, and consequently low yields of alkylate will be obtained. This fact was recognized early in the development of the alkylation process, when it was found that effective dispersion of the hydrocarbons in the acid is essential to obtain the best yields of product.

"6. Since concentrated sulfuric acid is a hydrogenation-dehydrogenation agent, the presence of diolefins in the olefin feed should have no effect on the character of the alkylate since these are readily hydrogenated to olefins. The presence of butadiene in concentrations as high as 22% [7, 36] caused no change in the composition or yield of alkylate. The only observed effect was the more rapid deterioration of the catalyst due to the dehydrogenation of part of the unsaturated hydrocarbon to form cyclic olefins as in conjunct polymerization."

No single mechanism so far proposed answers adequately all questions regarding the mechanism of alkylation of alkanes by alkenes or alkyl halides. Much more experimental work will be required to clarify the mechanism of these reactions and to give the reasons for formation of specific products. A theory for the future development of alkylation of alkanes should account kinetically and quantitatively for all reaction products. It must allow for the effect of various side reactions, including isomerization, hydrogenation-dehydrogenation, polymerization-depolymerization, and even dealkylation. In particular, all of the theories presented fail to correlate adequately the structure and chemical reactivity of hydrocarbons and related esters. Considerations of inter- and intramolecular forces are conspicuously lacking.

B. THERMAL ALKYLATION

Frey and Hepp concluded that, in thermal alkylation with ethene, replacement of the secondary hydrogen atom of propane by ethyl proceeds more rapidly than substitution of the primary hydrogen atom by ethyl (18):

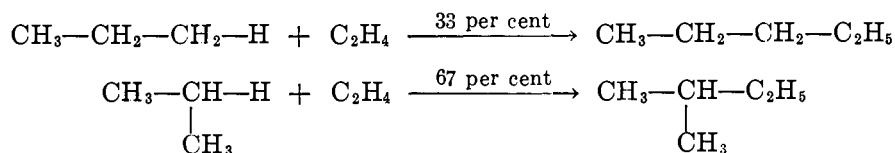

The propane alkylation mechanism was assumed to be a chain reaction, as in the thermal decomposition of alkanes (45). Propyl radicals were assigned the rôle of chain carriers:

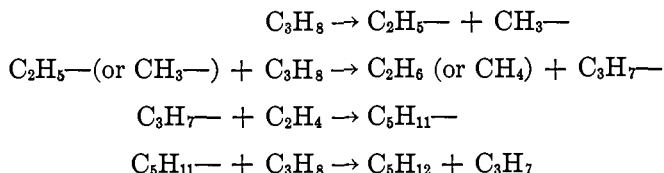

The presence of hexanes in the product from propane and ethene was ascribed in part to a reaction between propane and propene, which was stated to form substantial amounts of 2,3-dimethylbutane and 2-methylpentane under non-catalytic conditions. Heptanes were also present, indicating a further ethylation of the pentane(s) or a dimerization of ethene into butenes, which then alkylated a part of the propane feed:

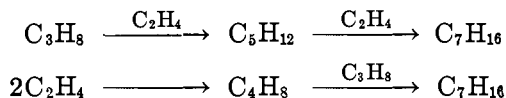

The expected order of hydrogen replacement in the thermal ethylation of alkanes was given as tertiary hydrogen > secondary hydrogen > primary hydrogen. Replacement of the tertiary hydrogen atom of isobutane by ethyl was actually observed to exceed that of the primary hydrogen atoms of isobutane by ethyl:

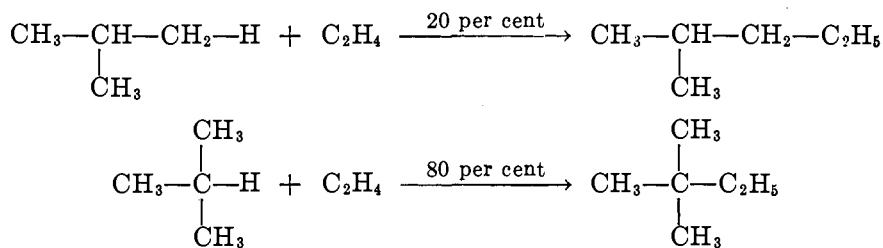

The presence of heptanes and octanes in the product from isobutane and ethene was ascribed to probable alkylations by propene and butenes:

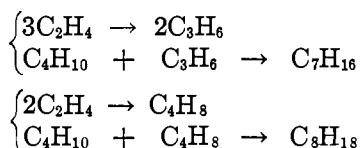

Schmerling (50) has pointed out that the difference between catalytic and thermal alkylation of isobutane with ethene can be explained by assuming that, as has already been discussed, the primary product in the catalytic reaction is an

ester, the carbon skeleton of which rearranges during its conversion into alkane, whereas the primary product of thermal alkylation is an alkane which does not isomerize under the reaction conditions.

VI. REFERENCES

- (1) ALDEN, R. C.: *Natl. Petroleum News* **32**, No. 26, R-234 to R-240 (1940).
- (2) ANGLO-IRANIAN OIL Co., LTD., HUMBLE OIL AND REFINING Co., SHELL DEVELOPMENT Co., STANDARD OIL DEVELOPMENT Co., AND THE TEXAS Co.: *Oil Gas J.* **38**, No. 27, 104-8 (1939); *Refiner Natural Gasoline Mfr.* **18**, 494-503 (1939).
- (3) BARROW, R. F., PEARSON, T. G., AND PURCELL, R. H.: *Trans. Faraday Soc.* **35**, 880-9 (1939).
- (4) BARTLETT, P. D., CONDON, F. E., AND SCHNEIDER, A.: *J. Am. Chem. Soc.* **66**, 1531-9 (1944).
- (5) BAWN, C. E. H., AND MILSTEAD, J.: *Trans. Faraday Soc.* **35**, 889-99 (1939).
- (6) BIRCH, S. F., AND DUNSTAN, A. E.: *Trans. Faraday Soc.* **35**, 1013-20 (1939).
- (7) BIRCH, S. F., DUNSTAN, A. E., FIDLER, F. A., PIM, F. B., AND TAIT, T.: *Ind. Eng. Chem.* **31**, 884-91 (1939).
- (8) BIRCH, S. F., DUNSTAN, A. E., FIDLER, F. A., PIM, F. B., AND TAIT, T.: *Ind. Eng. Chem.* **31**, 1079-83 (1939).
- (9) BIRCH, S. F., DUNSTAN, A. E., FIDLER, F. A., PIM, F. B., AND TAIT, T.: *J. Inst. Petroleum Tech.* **24**, 303-20 (1938); *Oil Gas J.* **37**, No. 6, 49, 52-5, 58 (1938).
- (9a) *Blueprint of Refinery Processes: Oil Gas J.* **43**, No. 47, 184 (1945).
- (10) BLUNCK, F. H., AND CARMODY, D. R.: *Ind. Eng. Chem.* **32**, 328-30 (1940).
- (11) BURTON, M., DAVIS, T. W., GORDON, A., AND TAYLOR, H. A.: *J. Am. Chem. Soc.* **63**, 1956-60 (1941).
- (12) CAESAR, P. D., AND FRANCIS, A. W.: *Ind. Eng. Chem.* **33**, 1426-8 (1941).
- (13) CIAPETTA, F. G.: *Abstracts of Papers, 108th Meeting of the American Chemical Society, New York, New York, September 11-15, 1944: Division of Petroleum Chemistry*, pp. 5-O and 6-O.
- (14) CIAPETTA, F. G.: *Papers Presented before the Petroleum Division of the American Chemical Society, Symposium on Catalysis in the Petroleum Industry, September 11-15, 1944, New York, New York*, pp. 5-19; *Ind. Eng. Chem.* **37**, 1210 (1945).
- (15) EGLOFF, G., HULLA, G., AND KOMAREWSKY, V. I.: *Isomerization of Pure Hydrocarbons*, pp. 32-3, 34-5, 65-6, 72-3, 236-7, 260-3, 270-1. Reinhold Publishing Corporation, New York (1942).
- (16) EGLOFF, G., WILSON, E., HULLA, G., AND VANARSDALL, P. M.: *Chem. Rev.* **20**, 345-411 (1937).
- (16a) EVERING, B. L., FRAGEN, N., AND WEEMS, G. S.: *Chem. Eng. News* **22**, 1898-1902 (1944).
- (17) FREY, F. E.: *Chem. Met. Eng.* **50**, No. 11, 126-8 (1943).
- (18) FREY, F. E., AND HEPP, H. J.: *Ind. Eng. Chem.* **28**, 1439-45 (1936).
FREY, F. E.: *Oil Gas J.* **35**, No. 34, 40, 43, 46, 49 (1937) (abbreviated version).
- (19) GERHOLD, C. G., IVERSON, J. O., NEBECK, H. J., AND NEWMAN, R. J.: *Trans. Am. Inst. Chem. Engrs.* **39**, 793-812 (1943); *Universal Oil Products Co. Booklet No. 253*.
- (20) GROSSE, A. V., AND IPATIEFF, V. N.: *J. Org. Chem.* **8**, 438-47 (1943); *Papers Presented before the General Meeting of the Petroleum Division of the American Chemical Society at Rochester, New York, September 6-10, 1937*, pp. 1-12.
- (21) GROSSE, A. V., ROSENBAUM, E. J., AND JACOBSON, H. F.: *Ind. Eng. Chem., Anal. Ed.* **12**, 191-4 (1940).
- (22) HELDMAN, J. D.: *J. Am. Chem. Soc.* **66**, 1789-91 (1944).
- (23) HELDMAN, J. D.: *J. Am. Chem. Soc.* **66**, 1791-3 (1944).
- (24) IPATIEFF, V. N.: *Catalytic Reactions at High Pressures and Temperatures*, pp. 563-4. The Macmillan Company, New York (1936).

- (24a) Reference 24, page 673.
(24b) Reference 24, pages 680-2.
(25) Reference 24, pages 682-4.
(26) IPATIEFF, V. N.: *Oil Gas J.* **37**, No. 46, 86, 88, 91, 93 (1939).
(27) IPATIEFF, V. N., AND GROSSE, A. V.: *Ind. Eng. Chem.* **28**, 461-4 (1936).
(28) IPATIEFF, V. N., AND GROSSE, A. V.: *J. Am. Chem. Soc.* **57**, 1616-21 (1935).
(29) IPATIEFF, V. N., AND GROSSE, A. V.: *J. Am. Chem. Soc.* **58**, 915-17 (1936).
(30) IPATIEFF, V. N., GROSSE, A. V., PINES, H., AND KOMAREWSKY, V. I.: *J. Am. Chem. Soc.* **58**, 913-15 (1936).
(31) IPATIEFF, V. N., AND PINES, H.: *J. Org. Chem.* **1**, 464-89 (1936).
(32) KASSEL, L. S.: *J. Chem. Phys.* **4**, 435-41 (1936).
(32a) KOCH, H., AND RICHTER, H.: *Ber.* **77B**, 127-32 (1944); *Chem. Abstracts* **39**, 903 (1945).
(33) LEIGHTON, P. A., AND HELDMAN, J. D.: *J. Am. Chem. Soc.* **65**, 2276-80 (1943).
(34) LINN, C. B.: Abstracts of Papers 108th Meeting American Chemical Society, New York, N. Y., September 11-15, 1944, Division of Organic Chemistry, p. 59M.
(35) LINN, C. B., AND GROSSE, A. V.: Papers Presented before the Petroleum Division of the American Chemical Society, Cleveland, Ohio, April 3-7, 1944, pp. 185-196; *Ind. Eng. Chem.* **37**, 924-9 (1945).
(36) McALLISTER, S. H.: *Natl. Petroleum News* **31**, No. 48, R-512 to R-516 (1939).
(37) McALLISTER, S. H., ANDERSON, J., BALLARD, S. A., AND ROSS, W. E.: *J. Org. Chem.* **6**, 647-68 (1941).
(38) NAMETKIN, S. S., AND ABAKUMOVSKAYA, L. N.: *J. Gen. Chem. (U.S.S.R.)* **6**, 1166-76 (1936).
(39) NAMETKIN, S. S., ABAKUMOVSKAYA, L. N., AND RUDENKO, M. G.: *J. Gen. Chem. (U.S.S.R.)* **7**, 759-62 (1937); *Oil Gas J.* **37**, No. 43, 52 (1939) [Abstract 50B, Process Management Co. Foreign Literature Service (J. G. Tolpin, Universal Oil Products Company)].
(40) NENITZESCU, C. D., AND DRAGAN, A.: *Ber.* **66**, 1897 (1933).
(41) OBERFELL, G. G., AND FREY, F. E.: *Oil Gas J.* **38**, No. 28, 50-1; No. 29, 70, 73, 74, 76 (1939); *Refiner Natural Gasoline Mfr.* **18**, No. 11, 108-15, 125 (1939).
(42) ORMANDY, W. R., AND CRAVEN, E. C.: *J. Inst. Petroleum Tech.* **13**, 311-20, 844-54 (1927).
(43) PARKS, G. S., AND TODD, S. S.: *Ind. Eng. Chem.* **28**, 418-19 (1936).
(44) PINES, H., GROSSE, A. V., AND IPATIEFF, V. N.: *J. Am. Chem. Soc.* **64**, 33-6 (1942).
(45) RICE, F. O.: *J. Am. Chem. Soc.* **53**, 1959 (1931); **55**, 3035 (1933).
(46) ROSENBAUM, E. J., GROSSE, A. V., AND JACOBSON, H. F.: *J. Am. Chem. Soc.* **61**, 689-92 (1939).
(47) ROSSINI, F. D., PROSEN, E. J. R., AND PITZER, K. S.: *J. Research Natl. Bur. Standards* **27**, 529-41 (1941) (Research Paper No. 1440).
(48) SCHMERLING, L.: Abstracts of Papers, 108th Meeting of the American Chemical Society, New York, New York, September 11-15, 1944, Division of Organic Chemistry, pp. 56M-57M; *J. Am. Chem. Soc.* **67**, 1438-41 (1945).
(48a) SCHMERLING, L.: Abstracts of Papers, 108th Meeting of the American Chemical Society, New York, New York, September 11-15, 1944, Division of Organic Chemistry, pp. 57M-58M; *J. Am. Chem. Soc.* **67**, 1152-4 (1945).
(49) SCHMERLING, L.: *J. Am. Chem. Soc.* **66**, 1422-3 (1944).
(50) SCHMERLING, L.: *J. Am. Chem. Soc.* **67**, 1778-83 (1945).
(51) SMITH, J. O., JR., AND TAYLOR, H. S.: *J. Chem. Phys.* **7**, 390-6 (1939).
(52) STERN, A. E., JOHNSTON, H. P., AND CLARK, C. R.: *J. Chem. Phys.* **7**, 970-1 (1939).
(53) UNIVERSAL OIL PRODUCTS CO.: Unpublished work mentioned by reference 50.
(54) WATERMAN, H. I., LEENDERTSE, J. J., AND HESSELINK, R.: *Rec. trav. chim.* **58**, 1040-7 (1939).
(55) WATERS, W. A.: *Trans. Faraday Soc.* **35**, 1020-1 (1939).
(56) WHITMORE, F. C.: *J. Am. Chem. Soc.* **54**, 3274-83 (1932).